

Sensor Controlled Robot Assembly Instructions

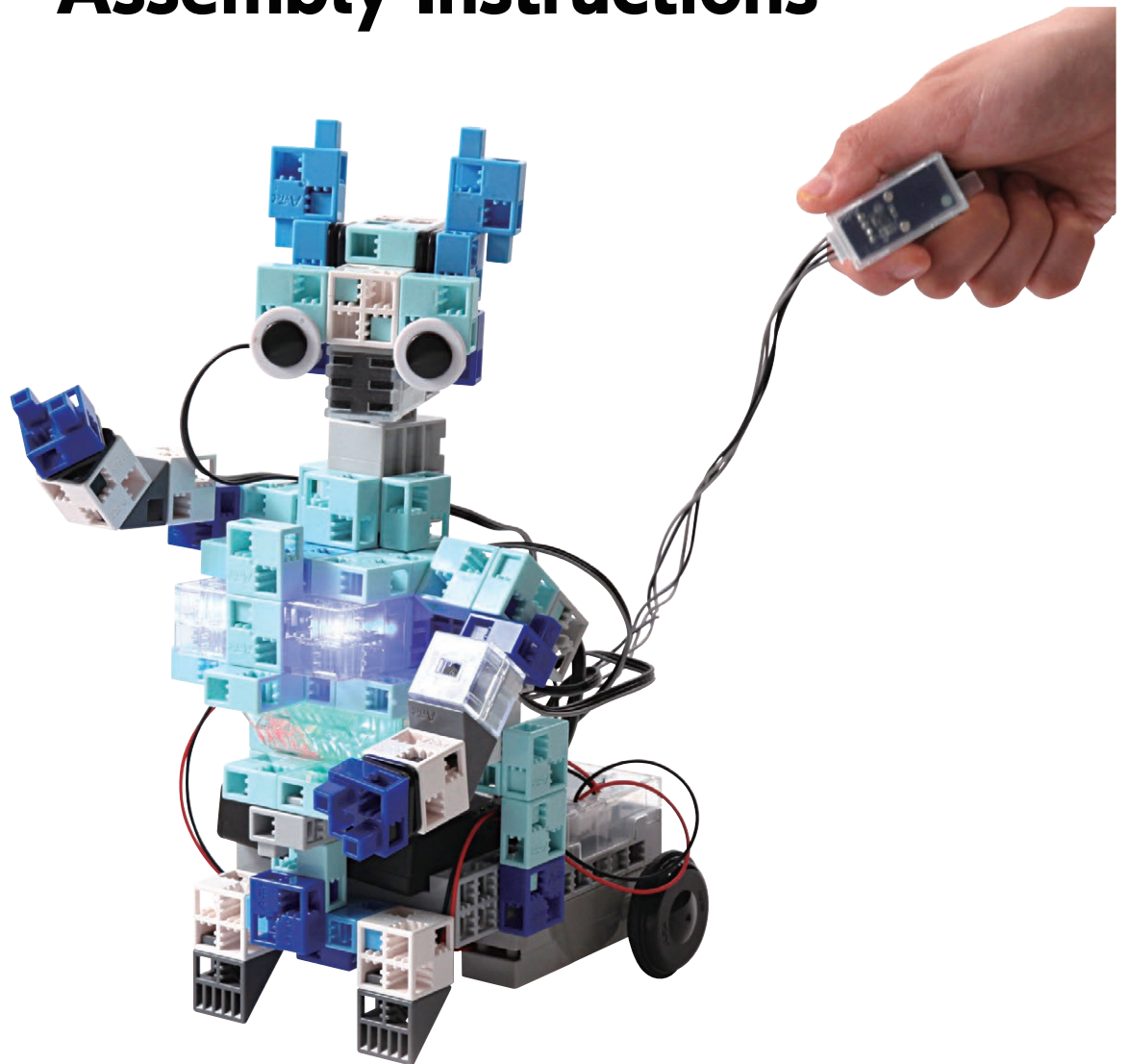

Artec Co., Ltd.

Address: 3-2-21 Kitakamei-cho, Yao-shi, Osaka
581-0066 Japan











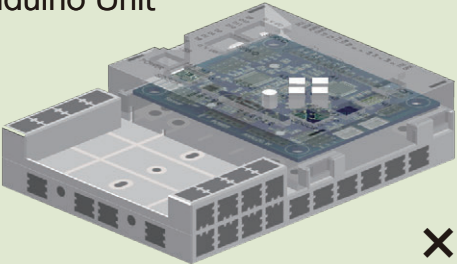
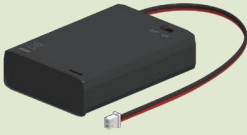

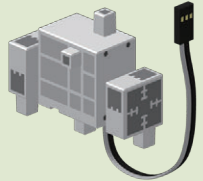
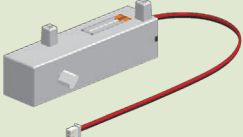
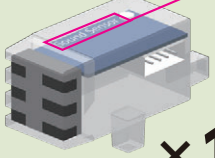
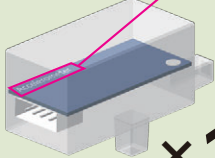
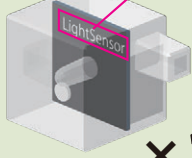
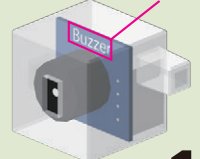
E-mail: export@artec-kk.co.jp

Website: www.artec-kk.co.jp/en

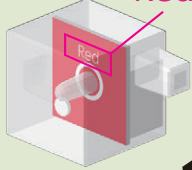
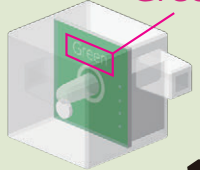
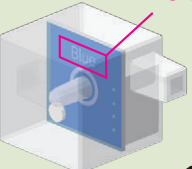
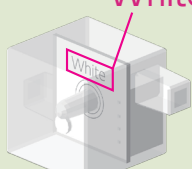
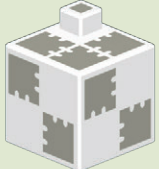
Artec[®] is a registered trademark of Artec Co., Ltd.
in multiple countries including Japan, South Korea,
Canada, and the USA.

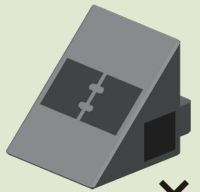
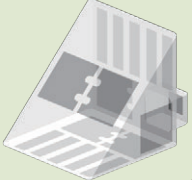
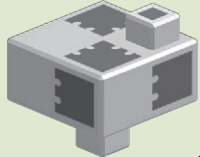
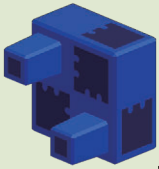
Sensor Controlled Robot

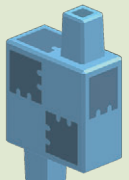
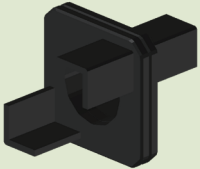
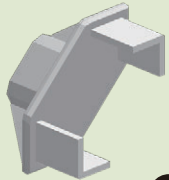
Components

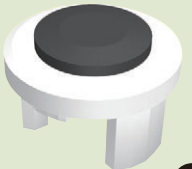
<p>Stduino Unit</p>  <p>×1</p>	<p>Battery Box</p>  <p>×1</p>	<p>USB Cable</p>  <p>×1</p>	<p>Servomotor</p>  <p>×3</p>	
<p>DC Motor</p>  <p>×2</p>	<p>Sound Sensor Sound Sensor</p>  <p>×1</p>	<p>Accelerometer Accelerometer</p>  <p>×1</p>	<p>Light Sensor Light Sensor</p>  <p>×1</p>	<p>Buzzer Buzzer</p>  <p>×1</p>
<p>Sensor Connecting Cable (three-wire 15 cm)</p>  <p>×6</p>	<p>Sensor Connecting Cable (three-wire 30 cm)</p>  <p>×1</p>	<p>Sensor Connecting Cable (four-wire 50 cm)</p>  <p>×1</p>	<p>LED (red) Red</p>  <p>×1</p>	<p>LED (green) Green</p>  <p>×1</p>
<p>LED (blue) Blue</p>  <p>×1</p>	<p>LED (white) White</p>  <p>×1</p>	<p>Basic Cube (white)</p>  <p>×10</p>	<p>Basic Cube (clear)</p>  <p>×2</p>	<p>Triangle A (gray)</p>  <p>×4</p>
<p>Triangle A (clear)</p>  <p>×2</p>	<p>Half A (light gray)</p>  <p>×1</p>	<p>Half B (blue)</p>  <p>×10</p>	<p>Half C (light aqua)</p>  <p>×39</p>	<p>Half D (aqua)</p>  <p>×8</p>
<p>Rotor Axis</p>  <p>×4</p>	<p>Hub</p>  <p>×2</p>	<p>O-ring</p>  <p>×2</p>	<p>Wheel</p>  <p>×2</p>	<p>Disk</p>  <p>×2</p>

Sensor Controlled Robot

Assembly Instruction Labels

D11

Shows the sticker number used for each servomotor. Use the motor with the correct sticker number.

x1

Shows the parts needed for assembly. Indicates the number of parts needed for assembly.



Indicates when the direction of a component must be changed for assembly.



Shows an image of the completely assembled item.

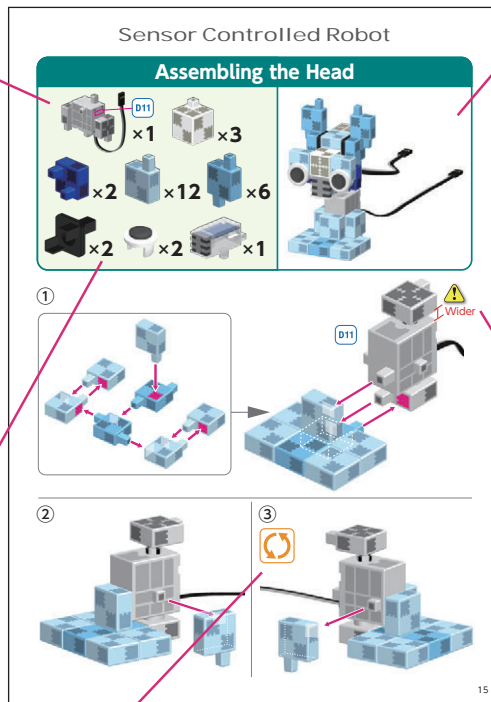

Indicates tips or warnings when building a specific item.

Handling the Servomotor

1 Orientation

The photo to the right shows the servomotor facing you. There are two shafts, the one with the wider space is the drive shaft and the one with the narrower space is the movable shaft.

★ When turning the drive shaft by hand, do so very slowly and gently.

Excessive pressure when turning may cause damage to the servomotor.

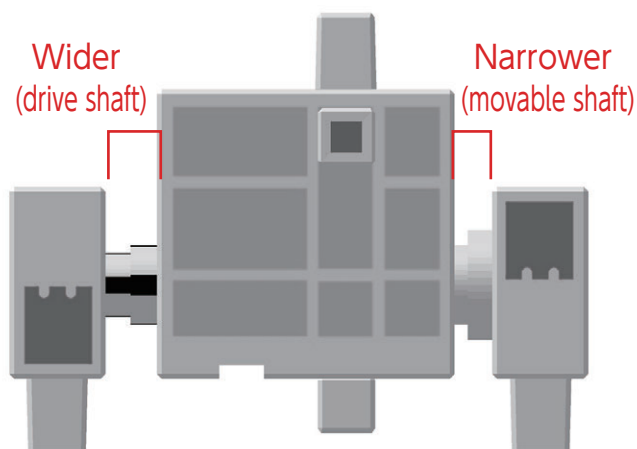

2 Calibration and Setting Connector Numbers

Before building your robot, read 6. Using Servomotors in the Studuino Icon Programming Environment Guide (download from <http://www.artec-kk.co.jp/robotist/>) for instructions on how to calibrate your servomotor.

Building your robot without calibrating your servomotor may cause damage or improper functionality.

★ Do not change the connector or the servomotor after calibration. Servomotor calibrations are unique to each servomotor.

Attaching Number Stickers

After calibration, we recommend putting a sticker on the connector used for the servomotor so it can be easily identified.

User stickers **D9**, **D10**, and **D11** when building your Sensor Controlled Robot.

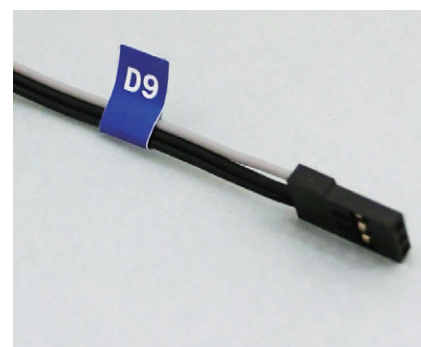

Sensor Controlled Robot

Preparation

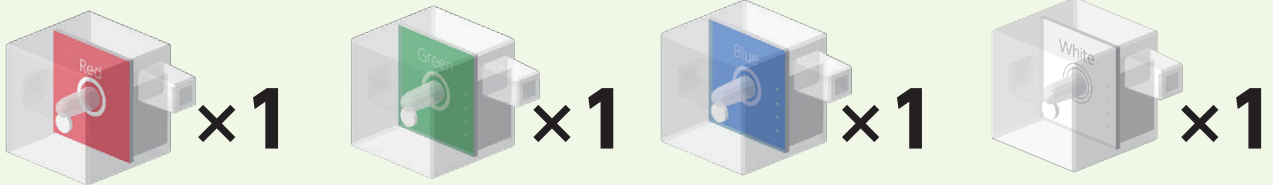
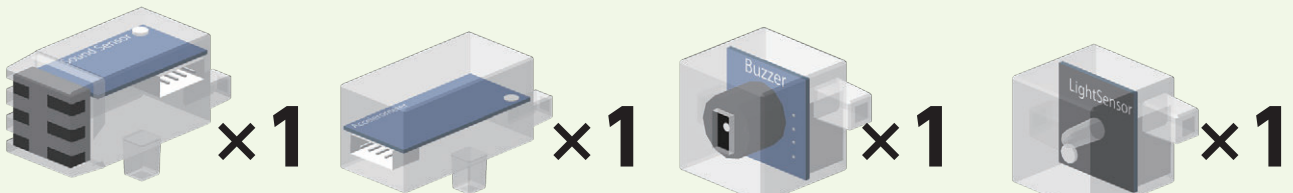

Connect the sensor connecting cable to each sensor.

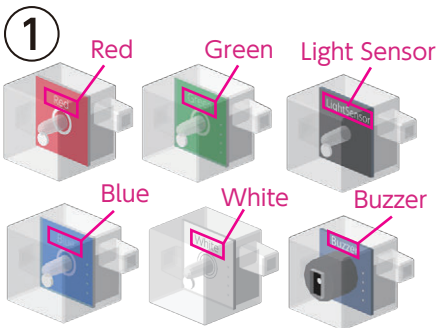

Sensor Connecting Cable (three-wire 15 cm)

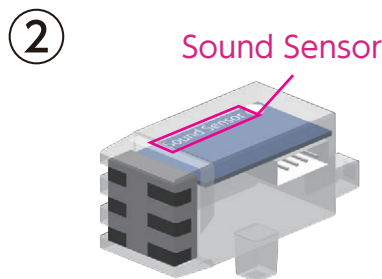
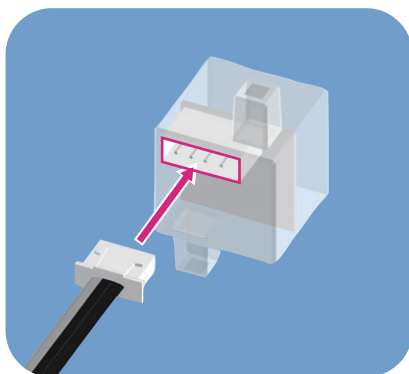
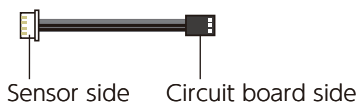

Sensor Connecting Cable (three-wire 30 cm)

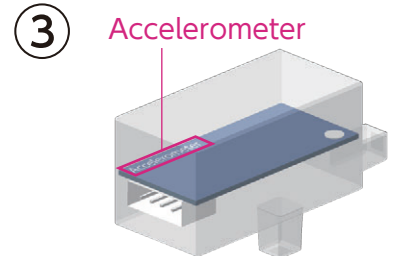
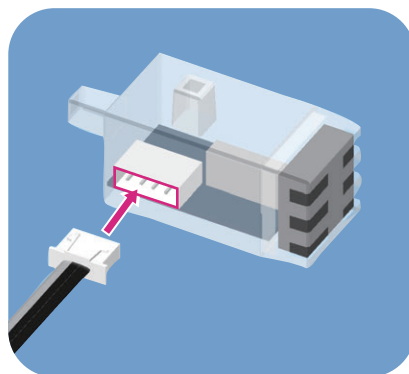

Sensor Connecting Cable (four-wire 50 cm)

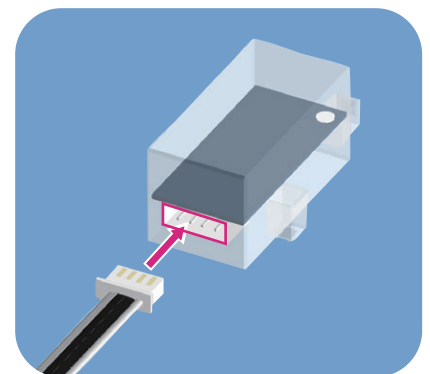

 Make sure the cables are inserted correctly!

Sensor Controlled Robot

Assembling the Lower Body

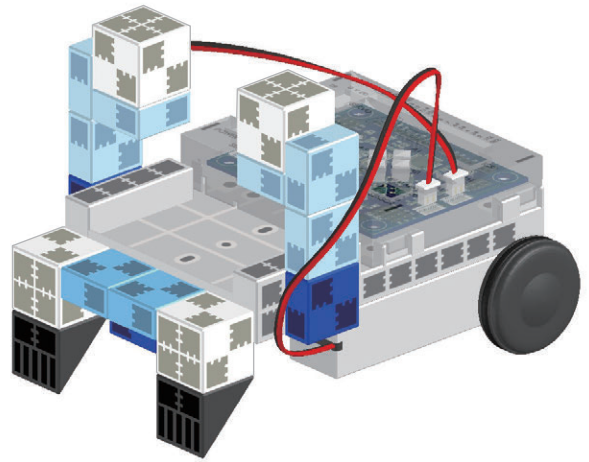
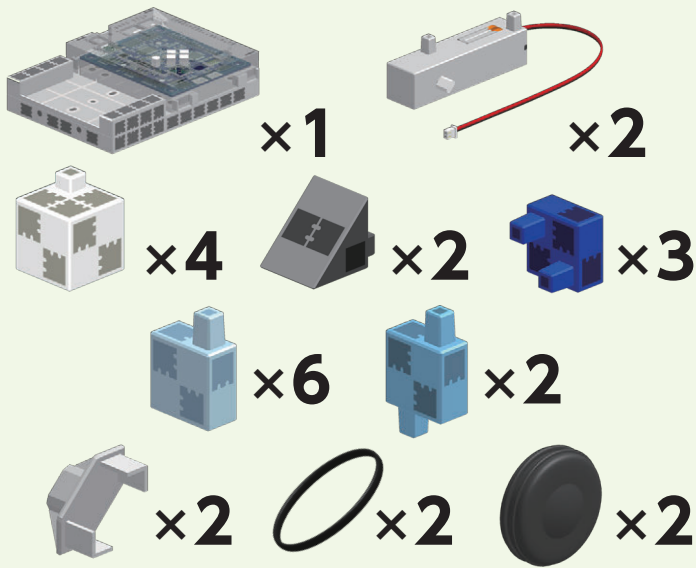

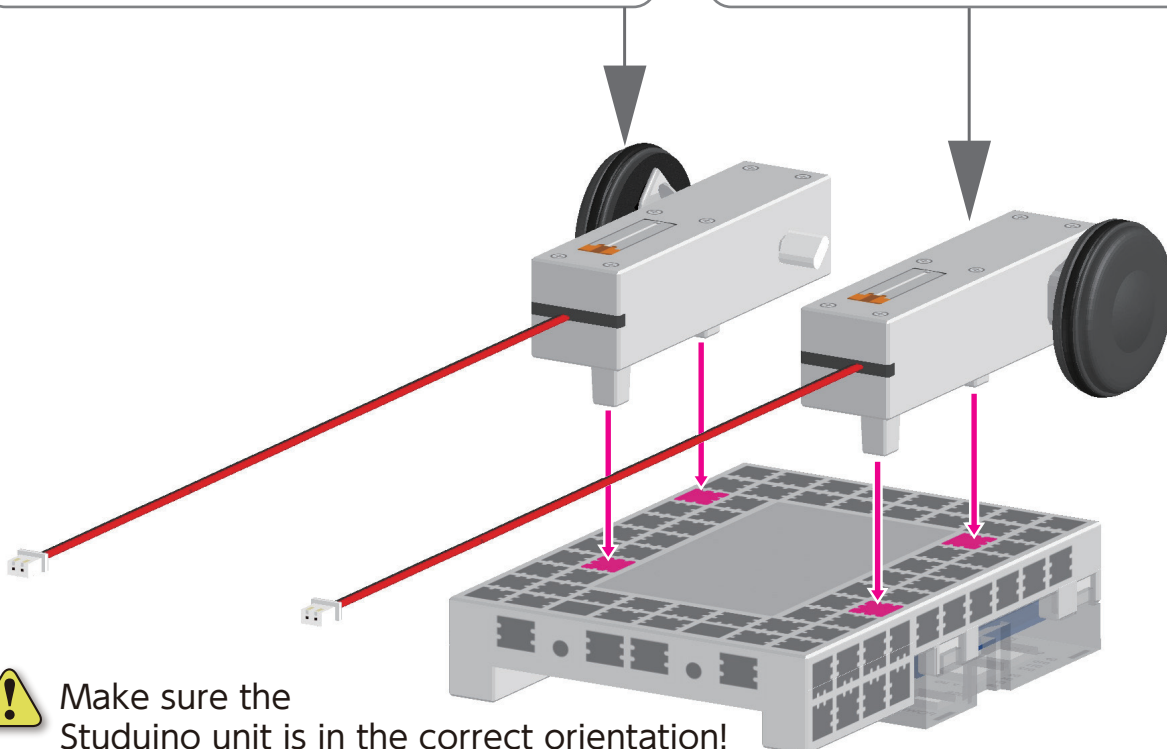
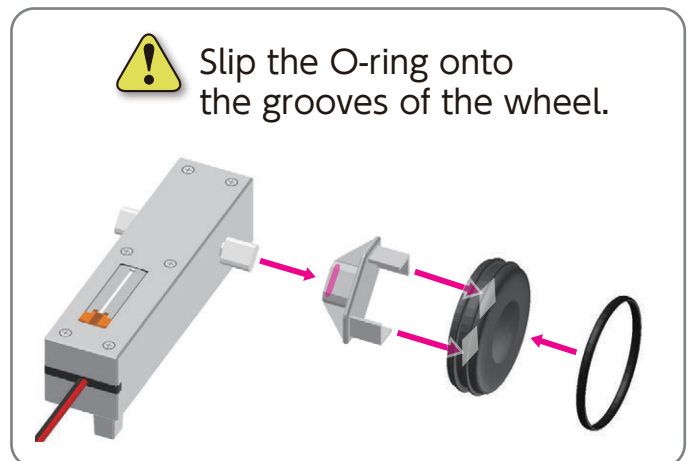
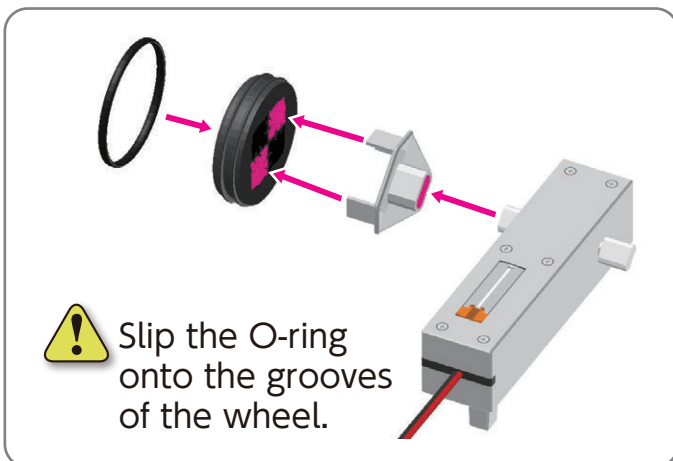

①

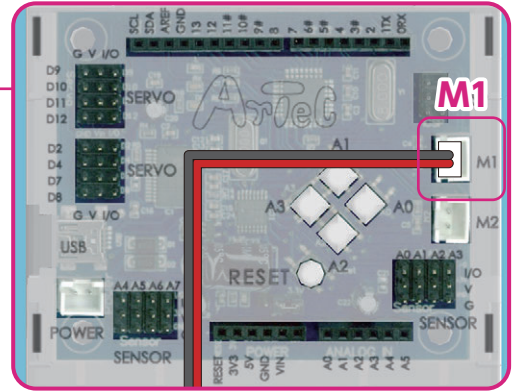
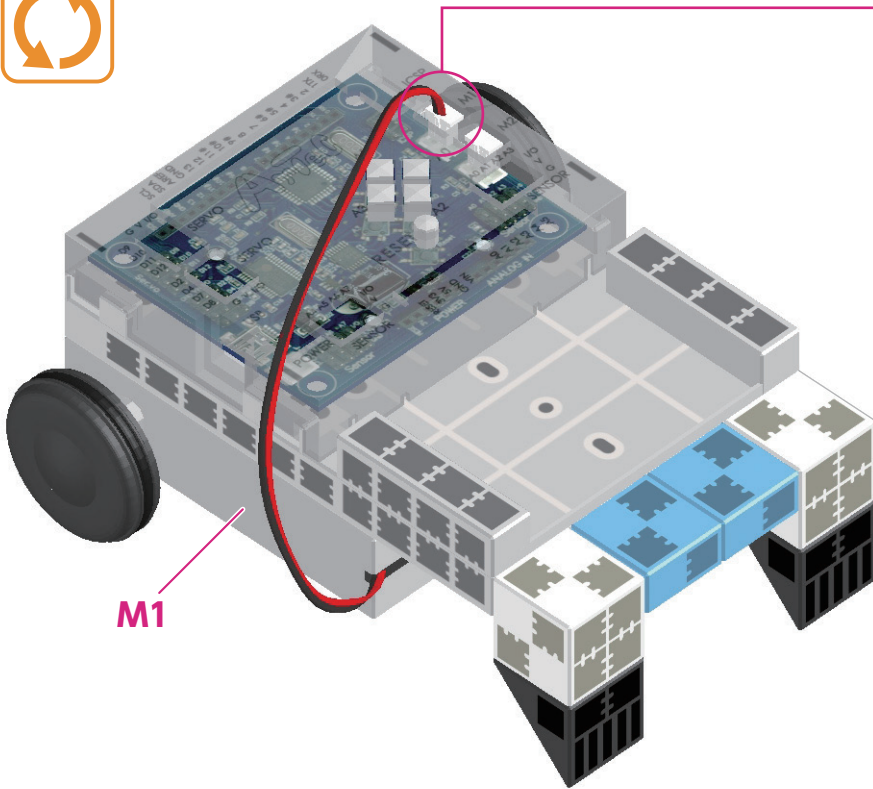

Sensor Controlled Robot

④ Connect to **M1**.



 Make sure the cables are inserted correctly!

⑤ Connect to **M2**.

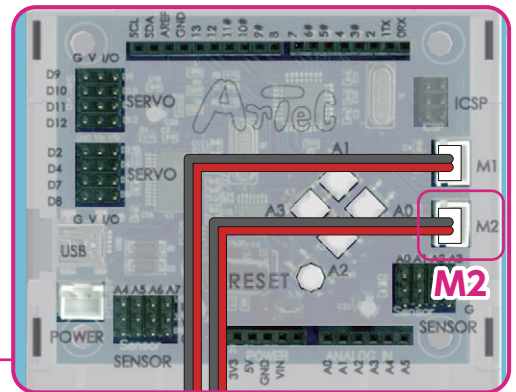
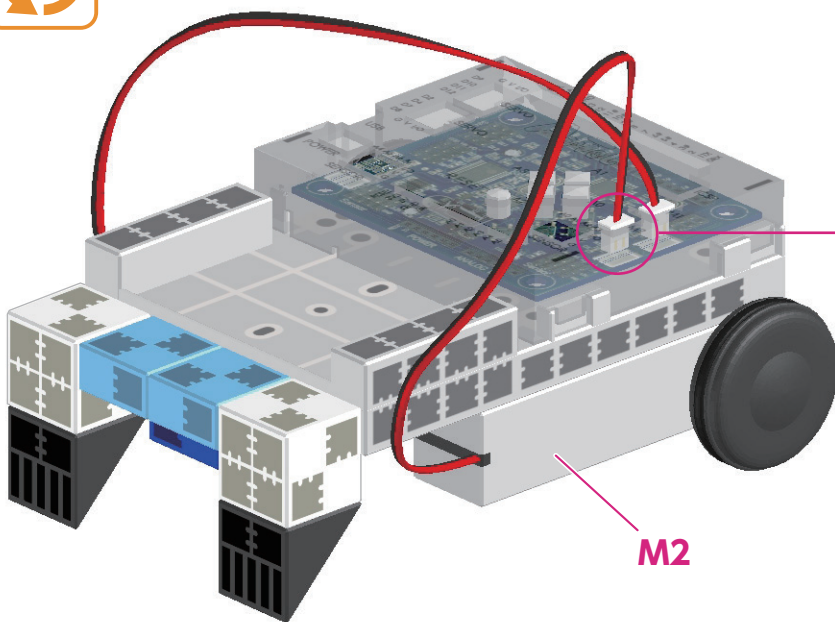

 Make sure the cables are inserted correctly!

Sensor Controlled Robot

6

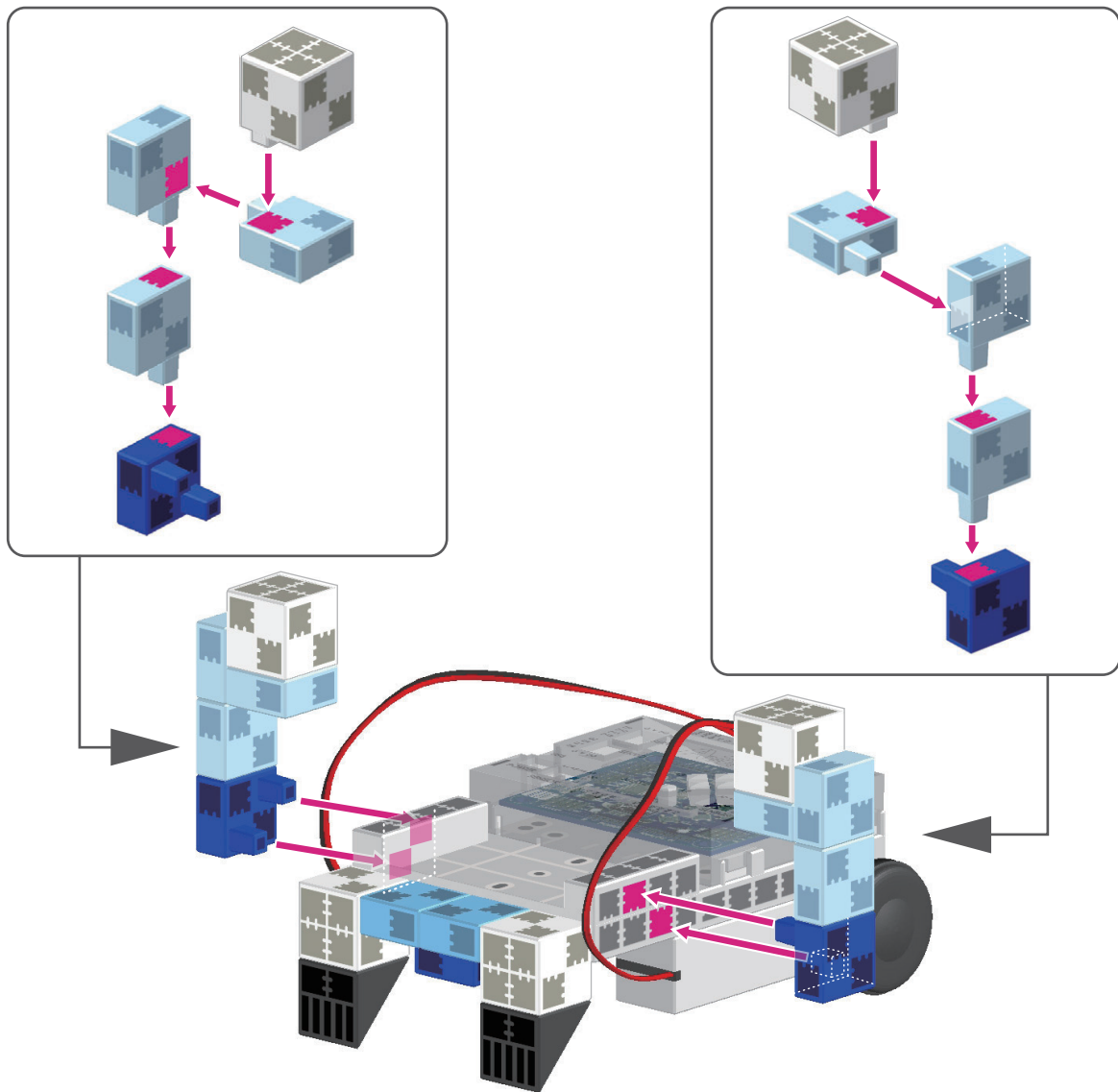

Completed Lower Body

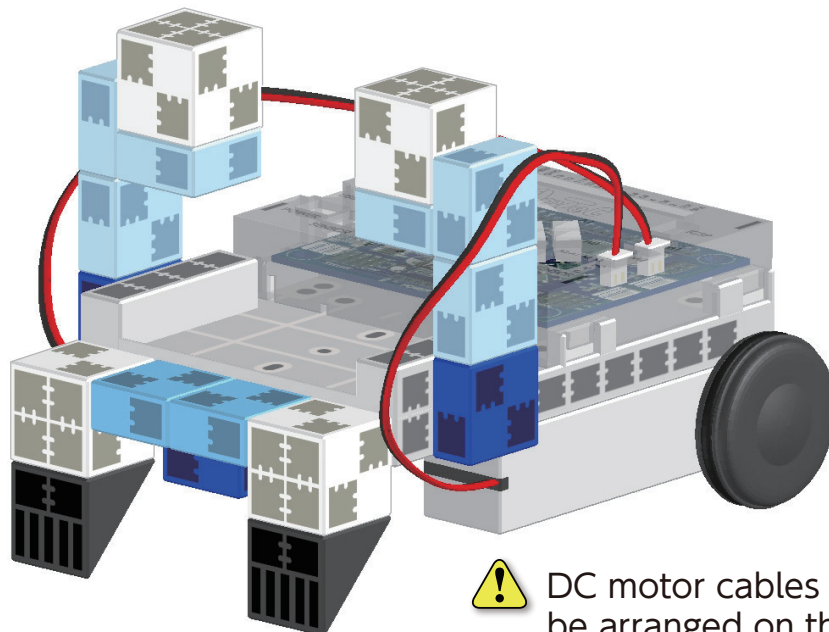

DC motor cables should be arranged on the outside of the car body.

Sensor Controlled Robot

Assembling the Torso

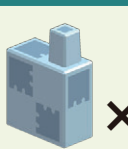
 **x2**  **x2**  **x15**

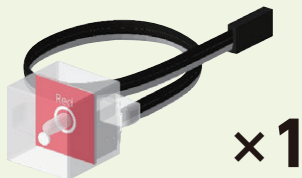
 **x1**

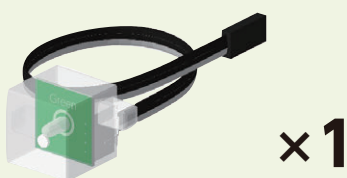
 **x1**

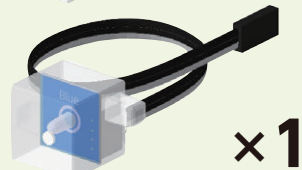
 **x1**

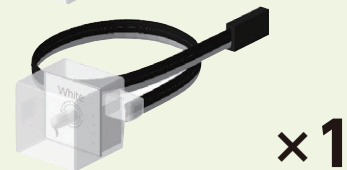
 **x1**

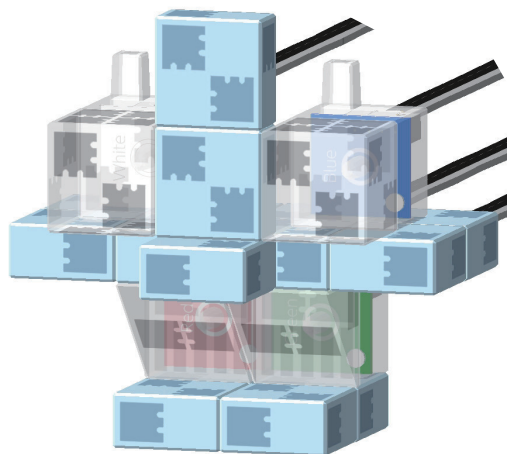

①

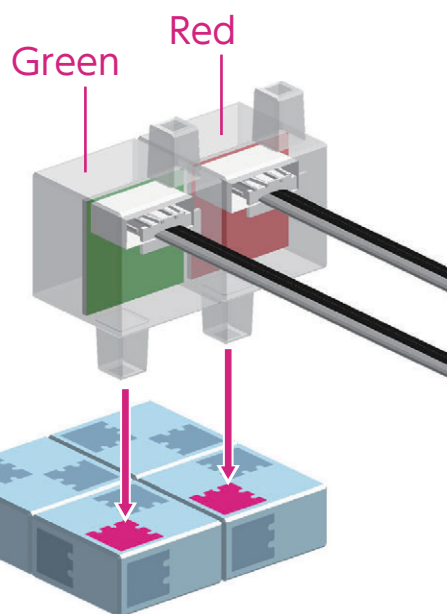
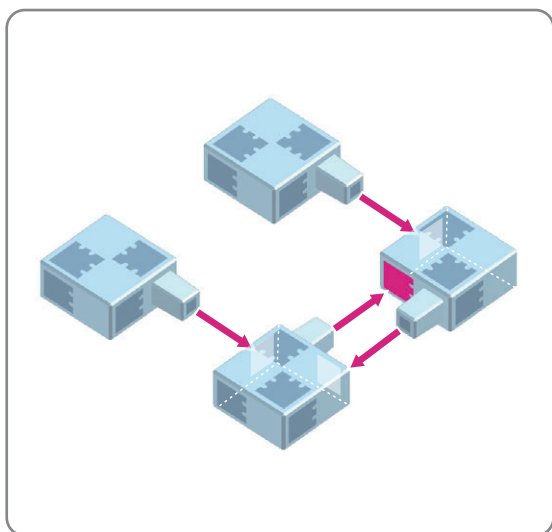

②

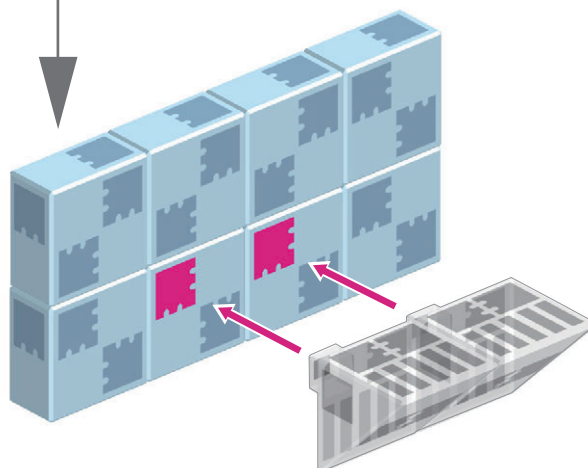
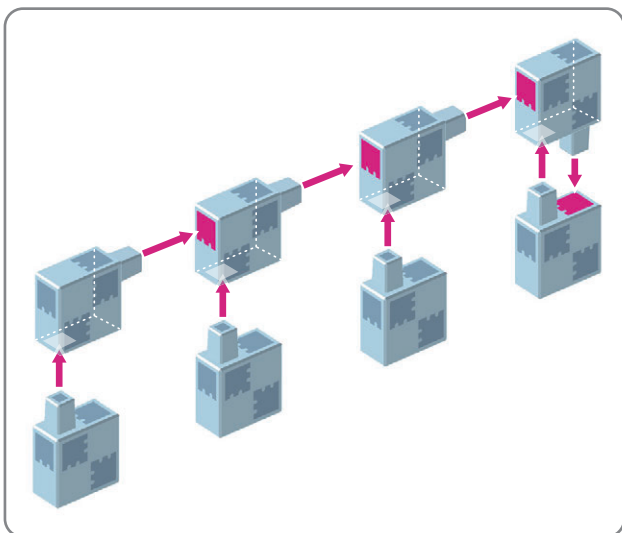

Sensor Controlled Robot

③

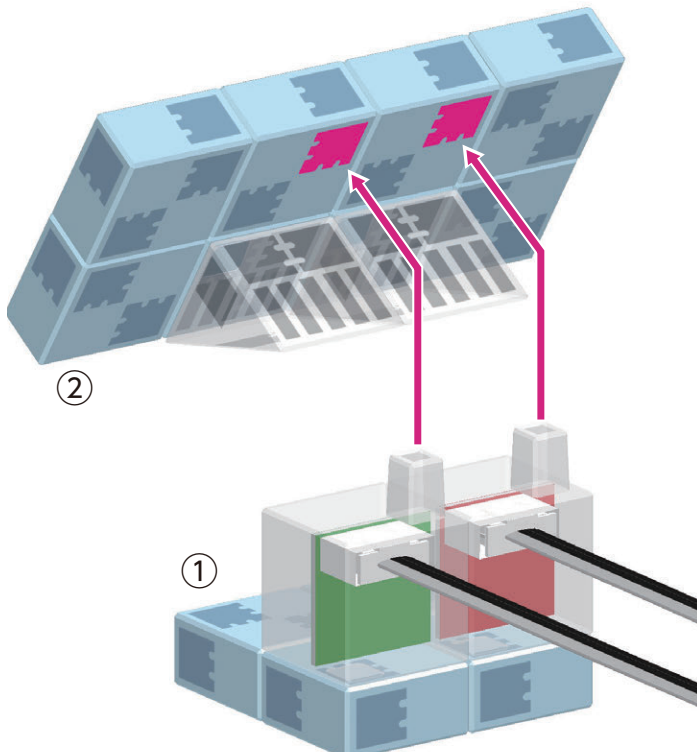

④

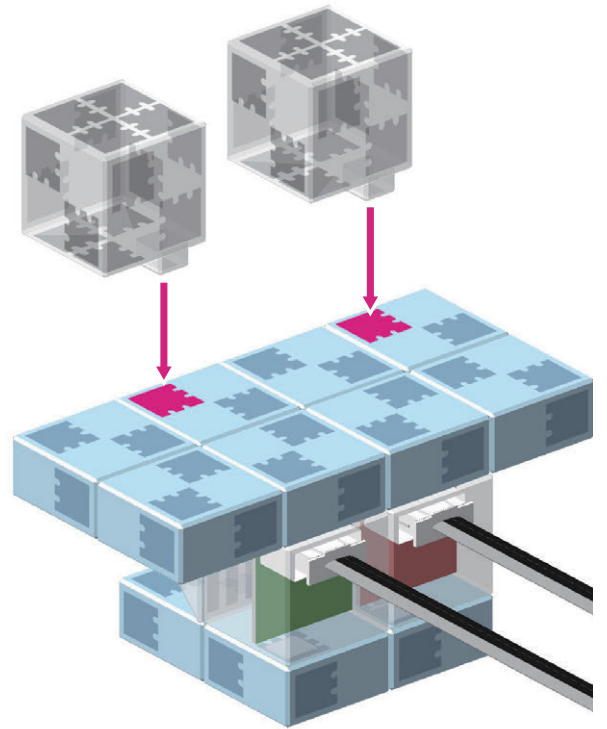

⑤

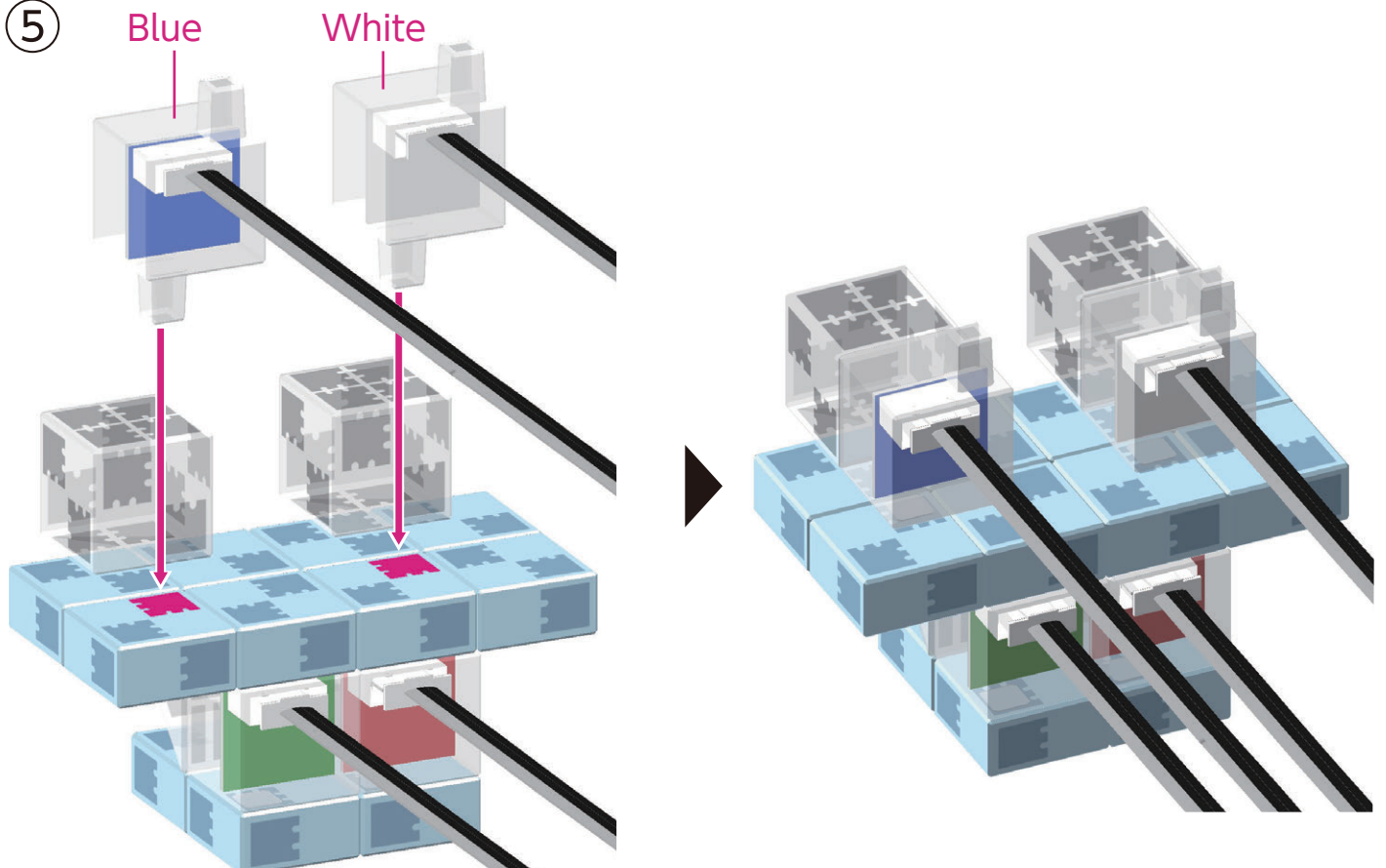

Sensor Controlled Robot

7

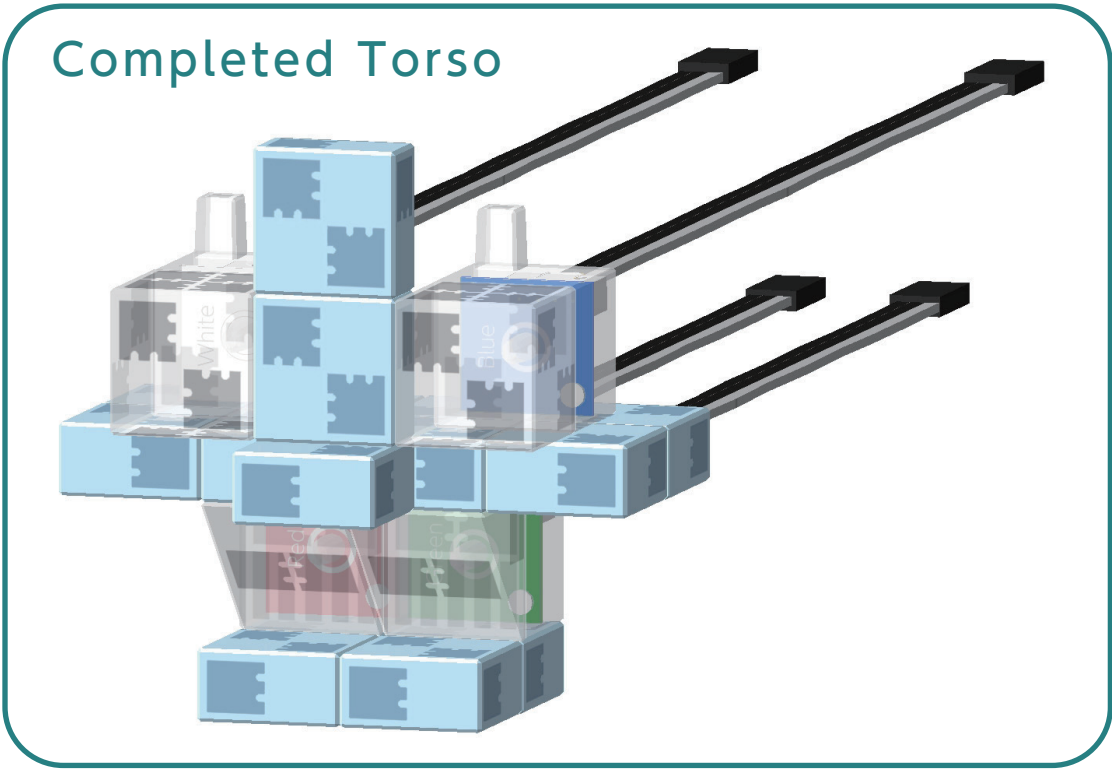
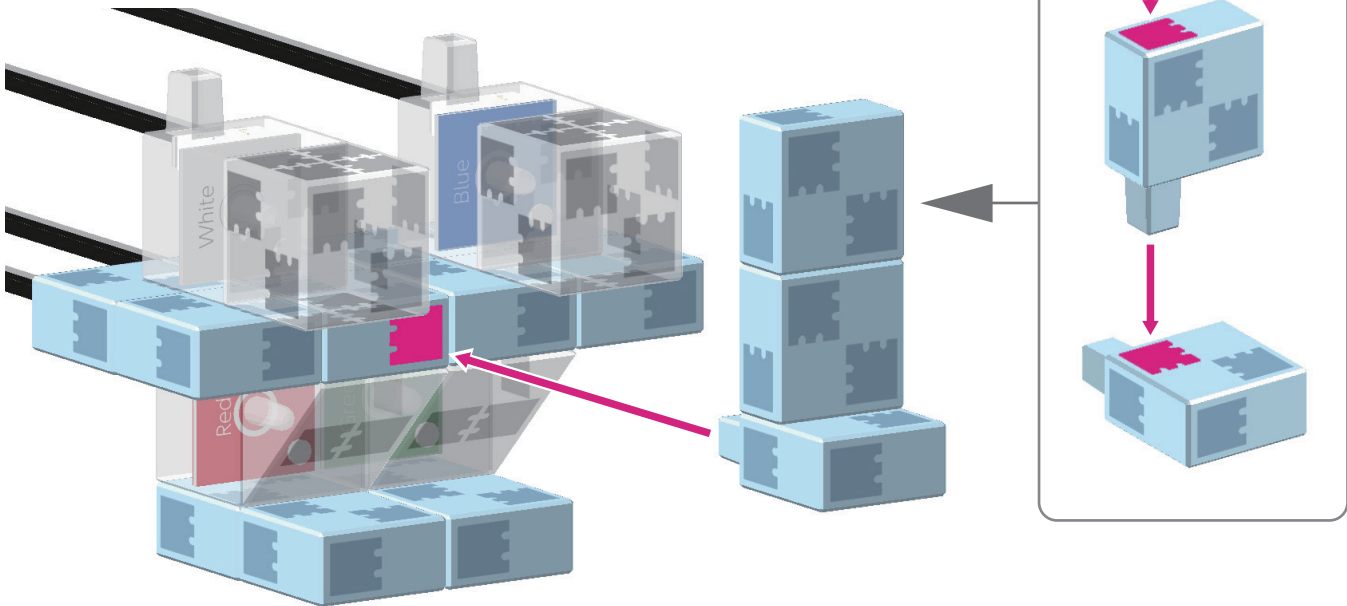

Sensor Controlled Robot

Assembling the Right Arm

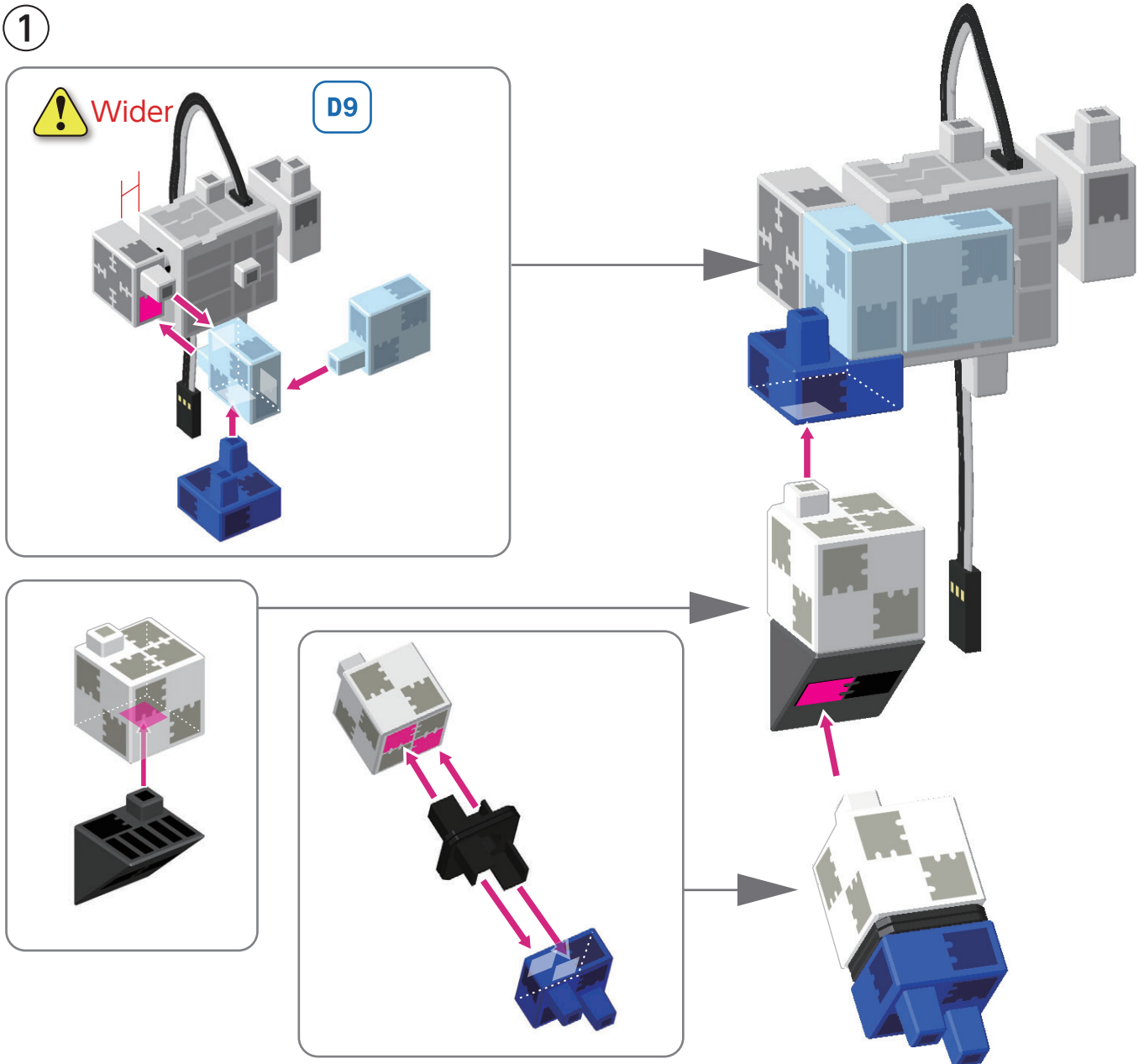
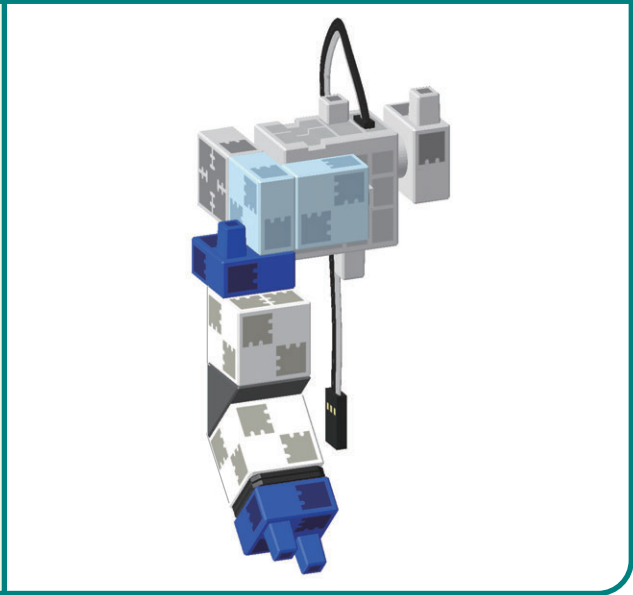
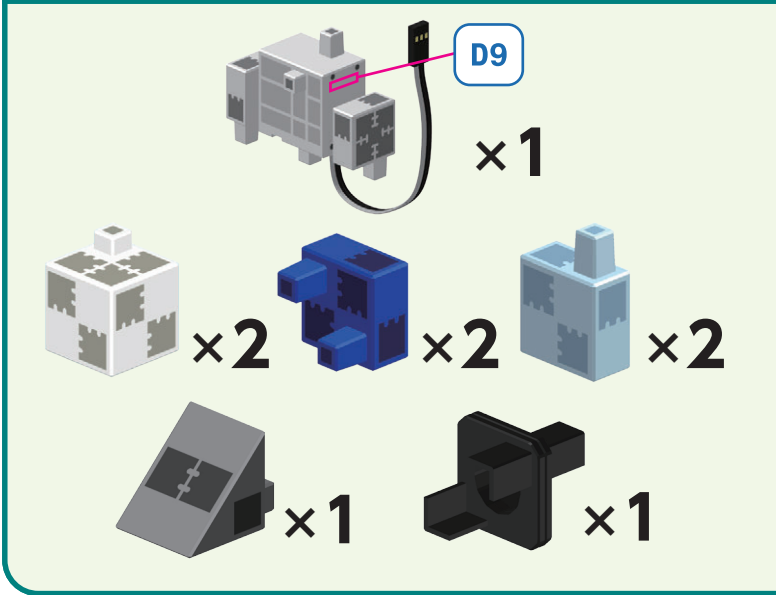

Sensor Controlled Robot

Assembling the Left Arm

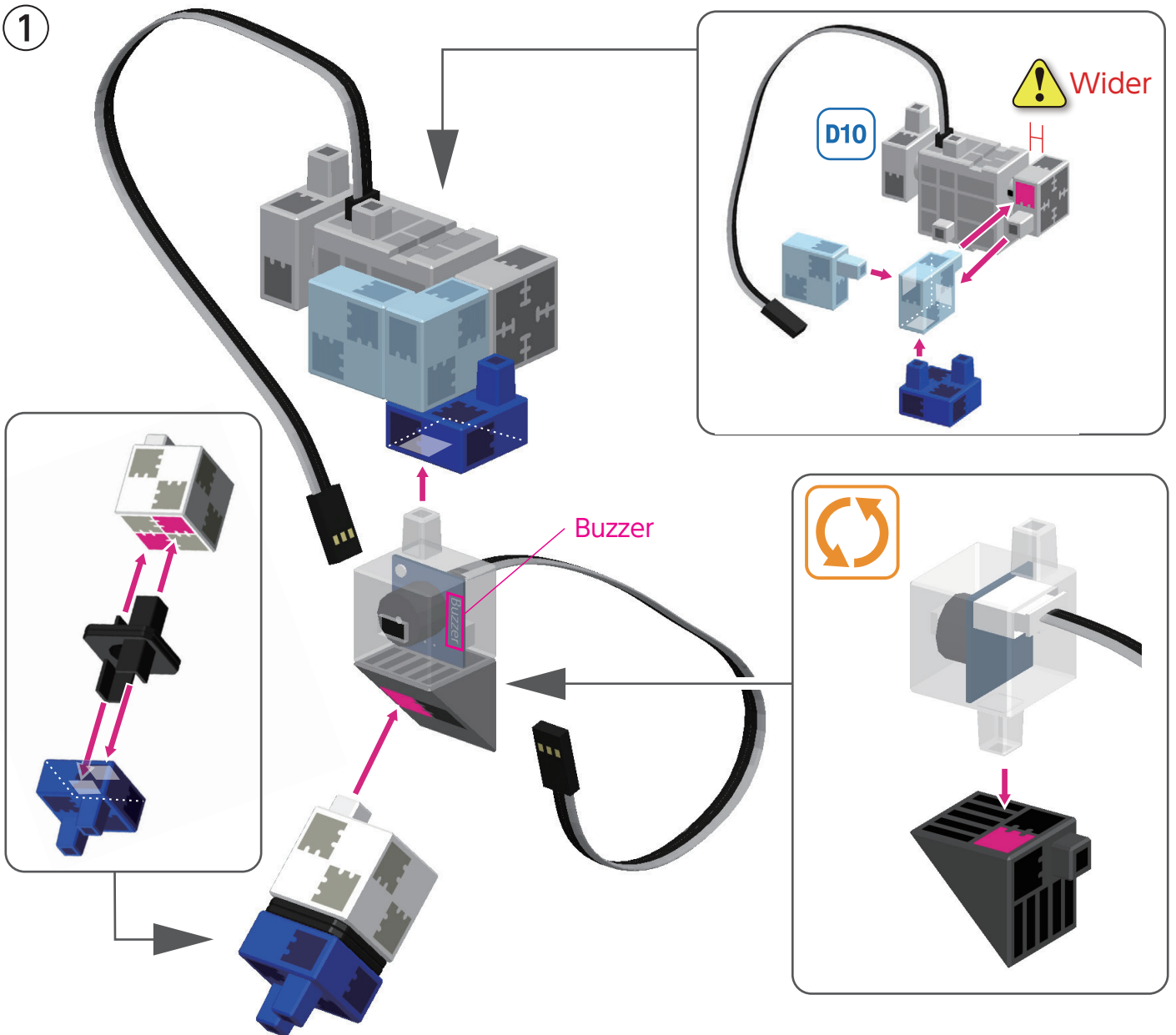
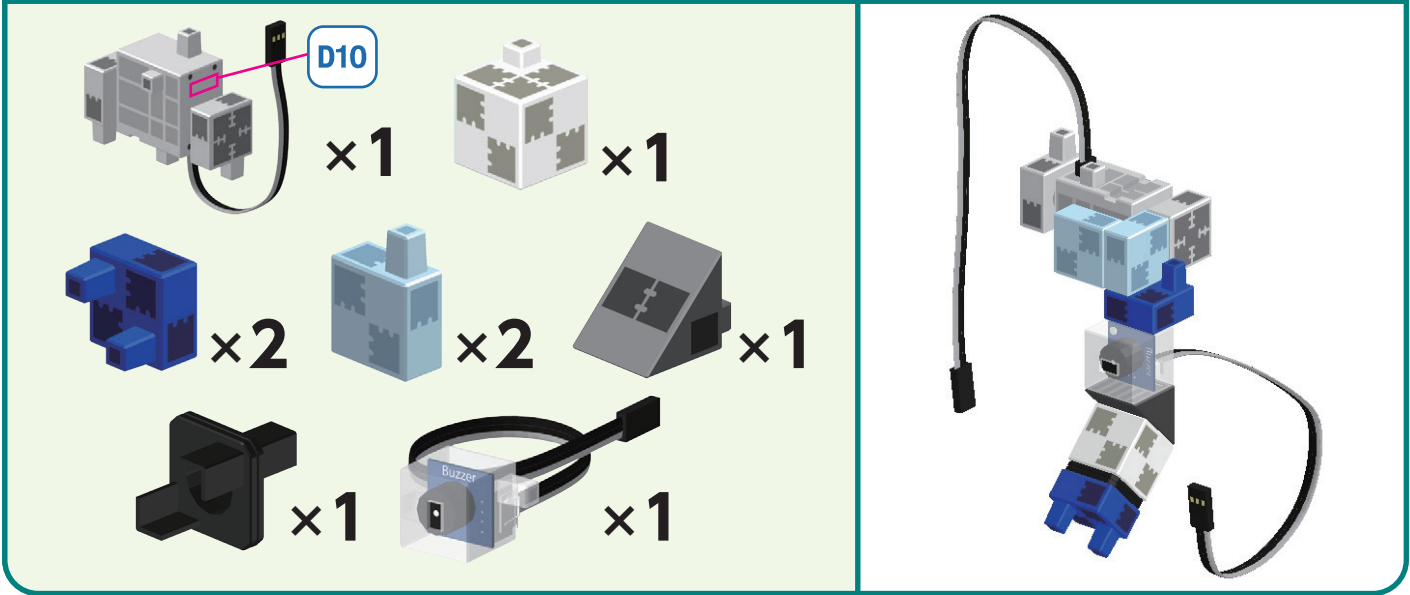

Sensor Controlled Robot

Assembling the Head

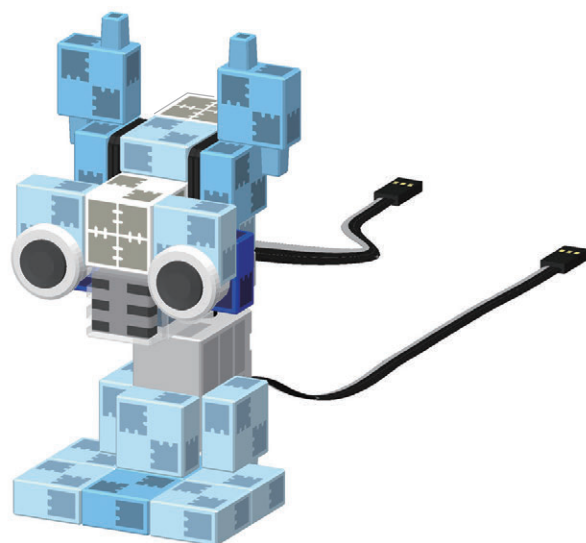
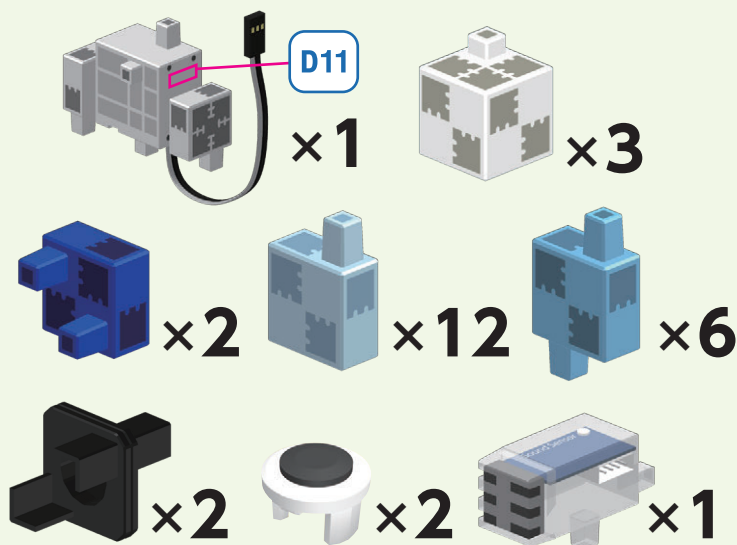

①

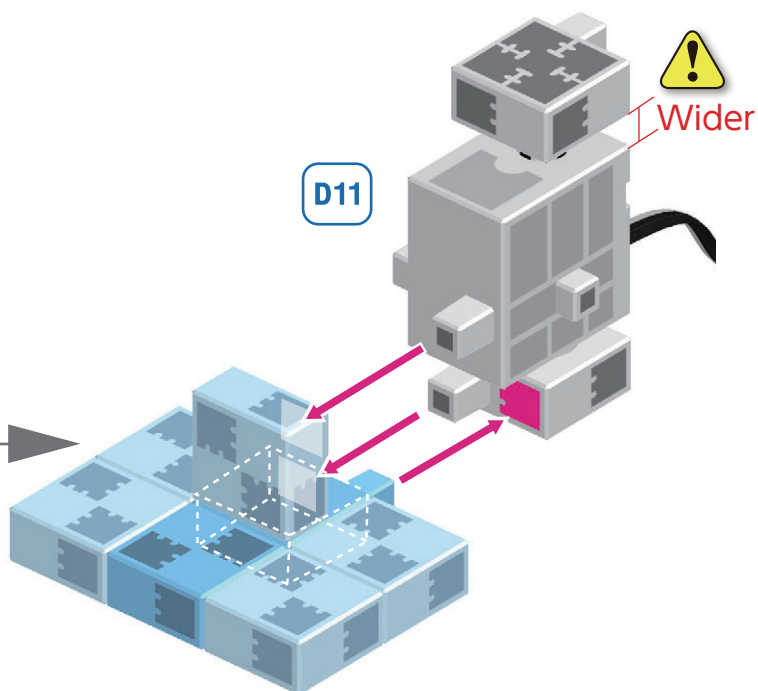
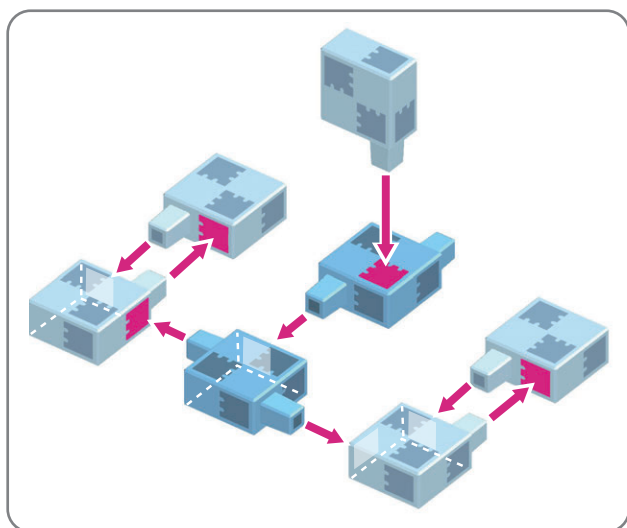

②

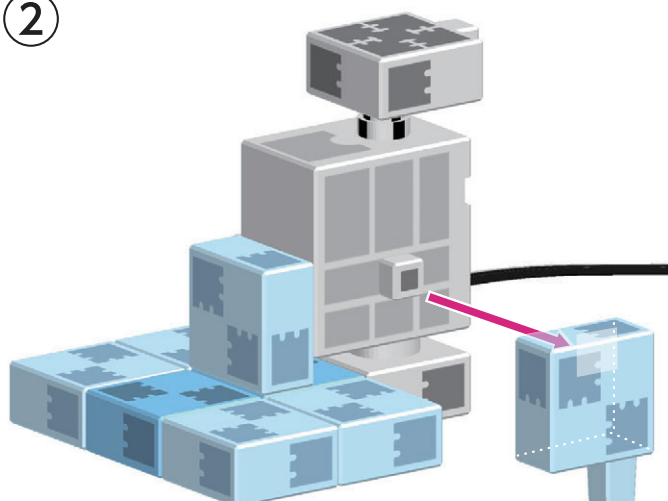

③

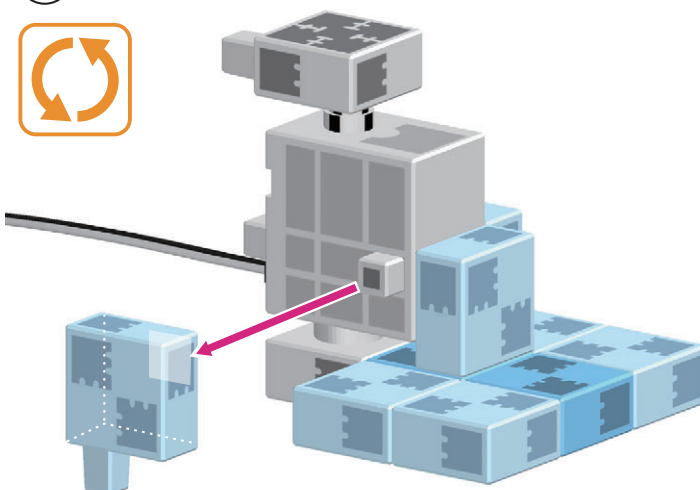

Sensor Controlled Robot

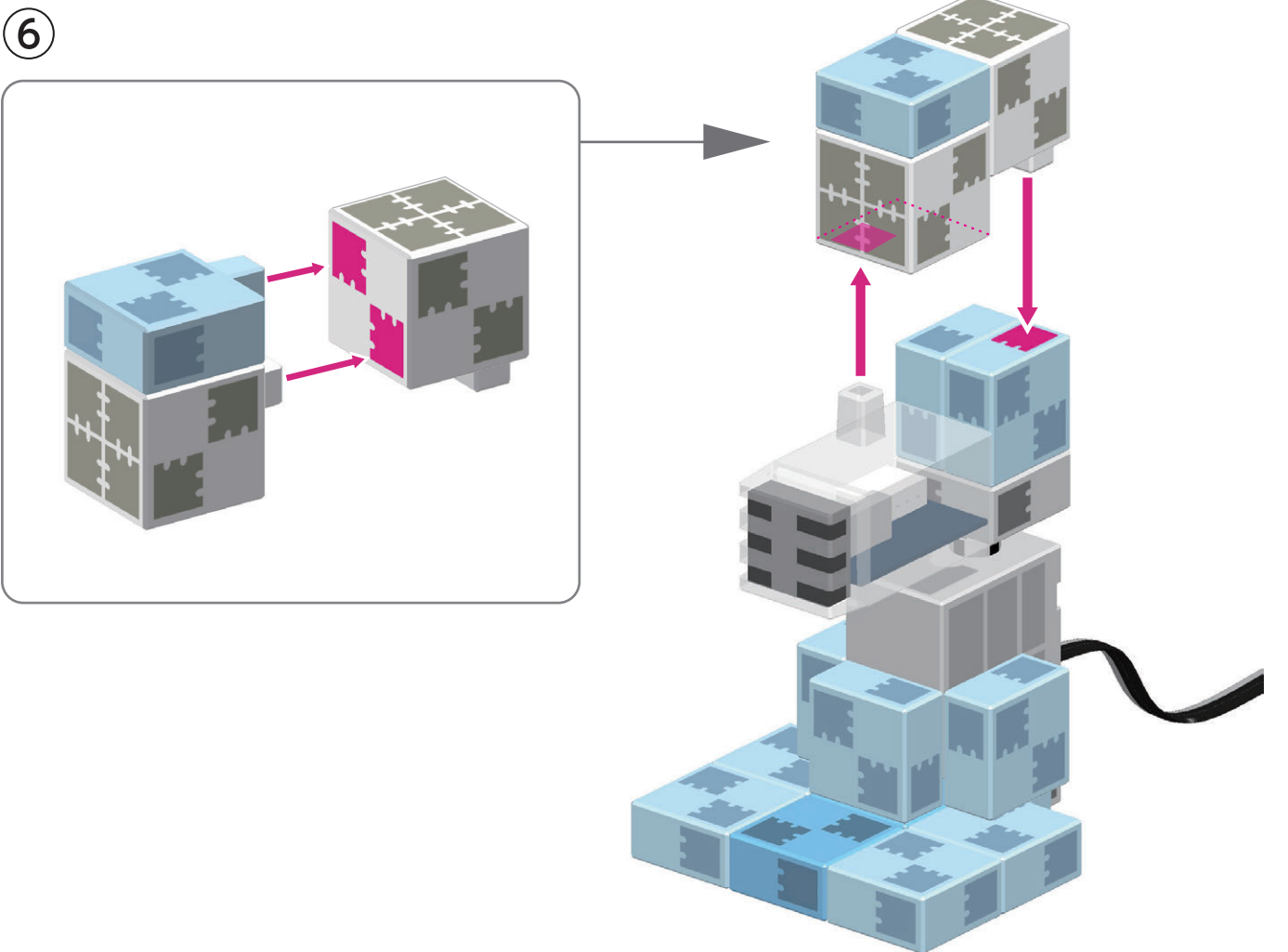
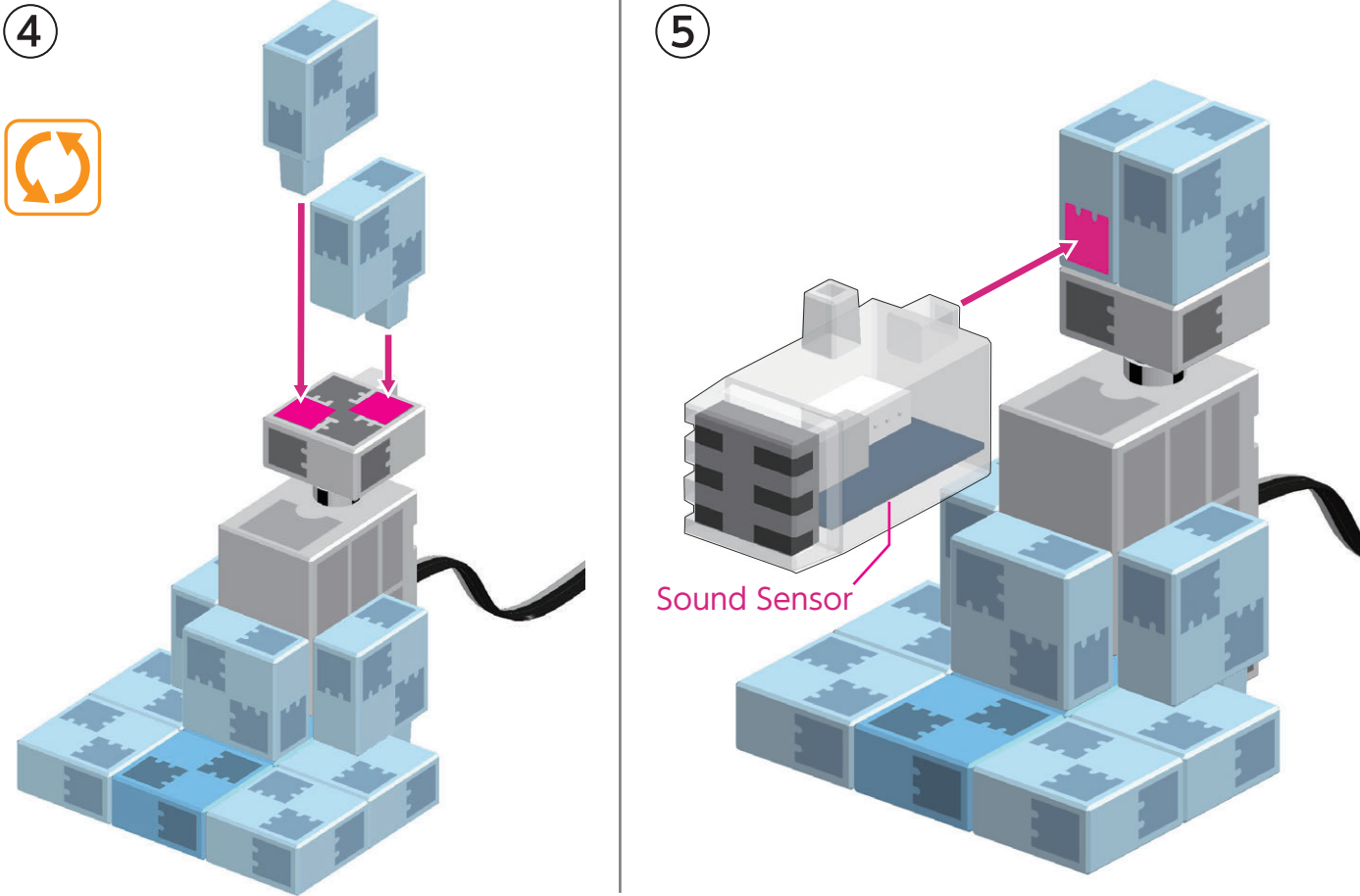

Sensor Controlled Robot

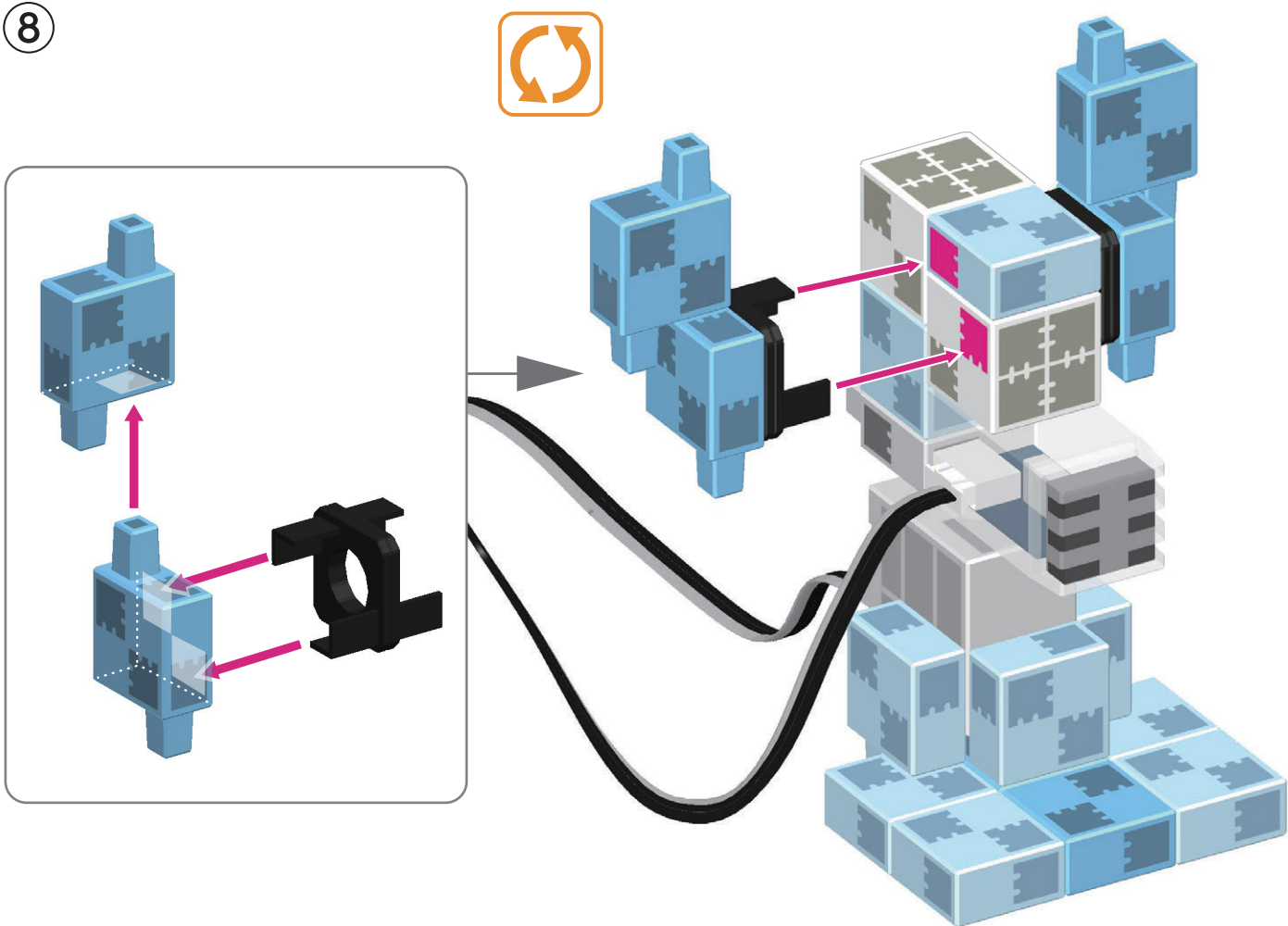
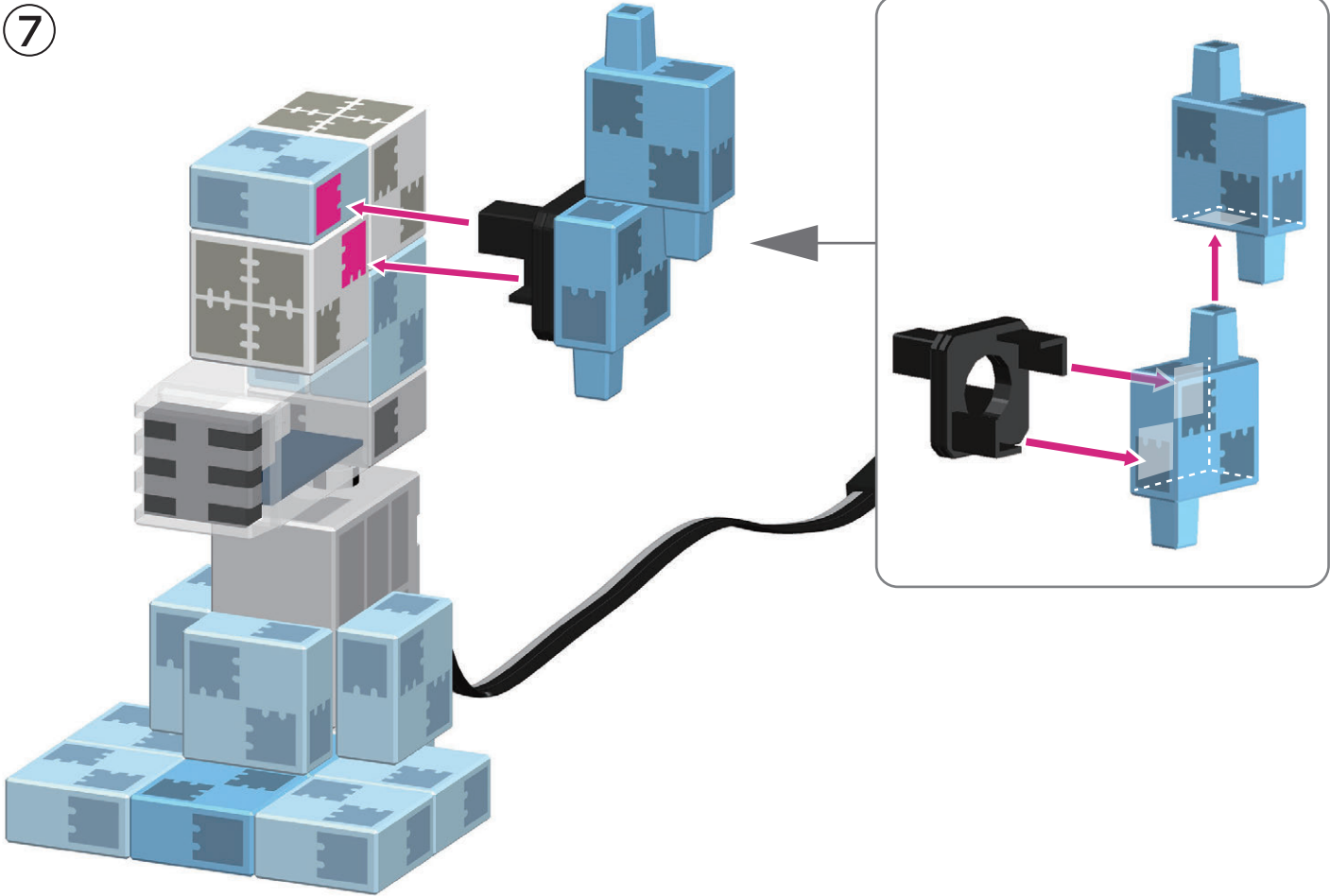

Sensor Controlled Robot

9

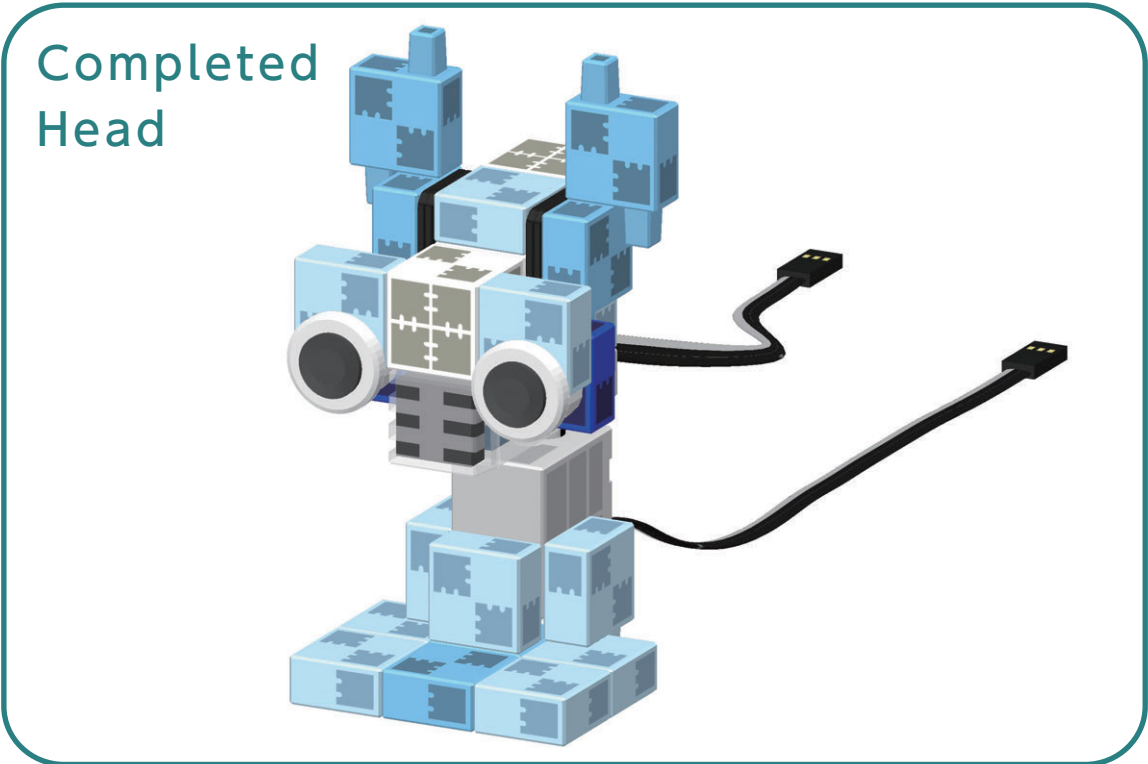
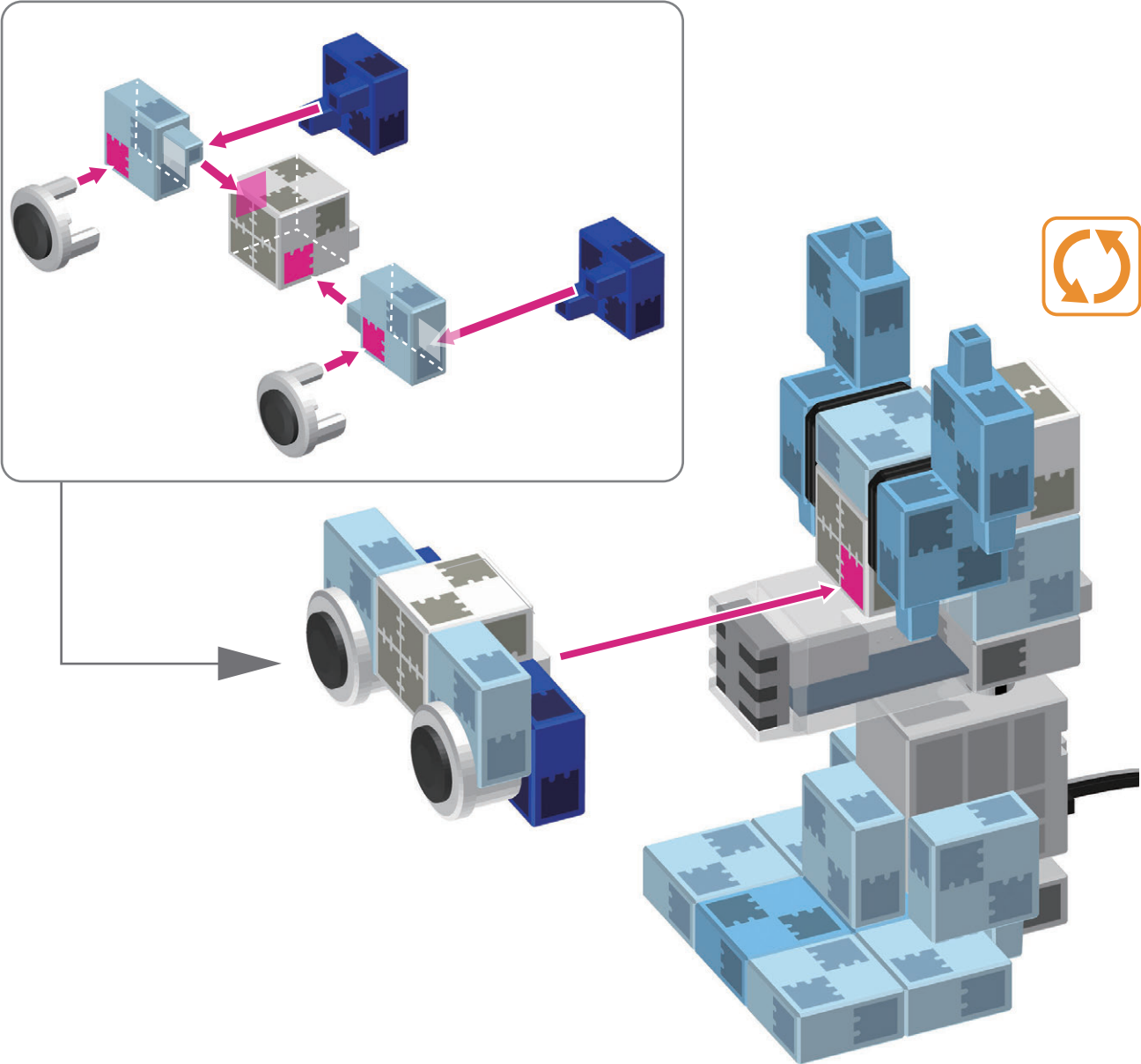

Sensor Controlled Robot

整体的组装

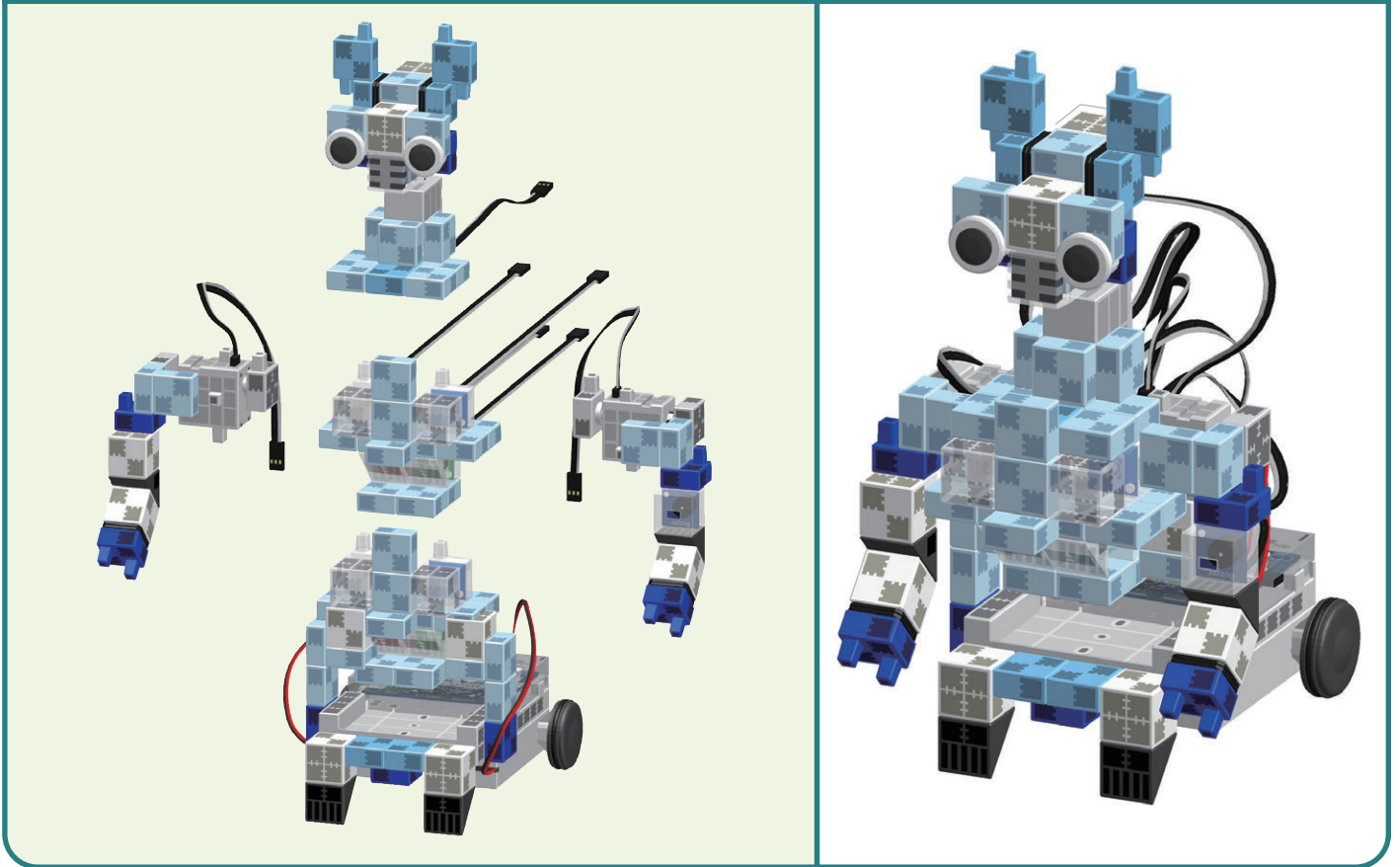

① 将伺服电机 **D9** 的线连接至 Studuino 主体相应的位置。

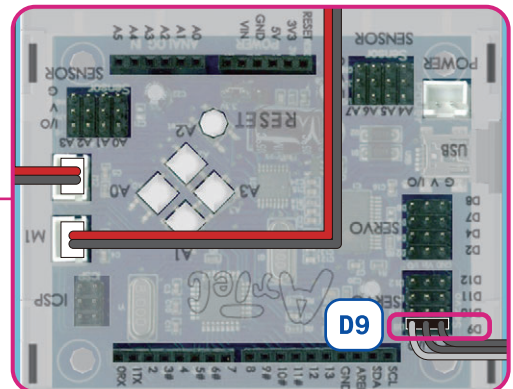
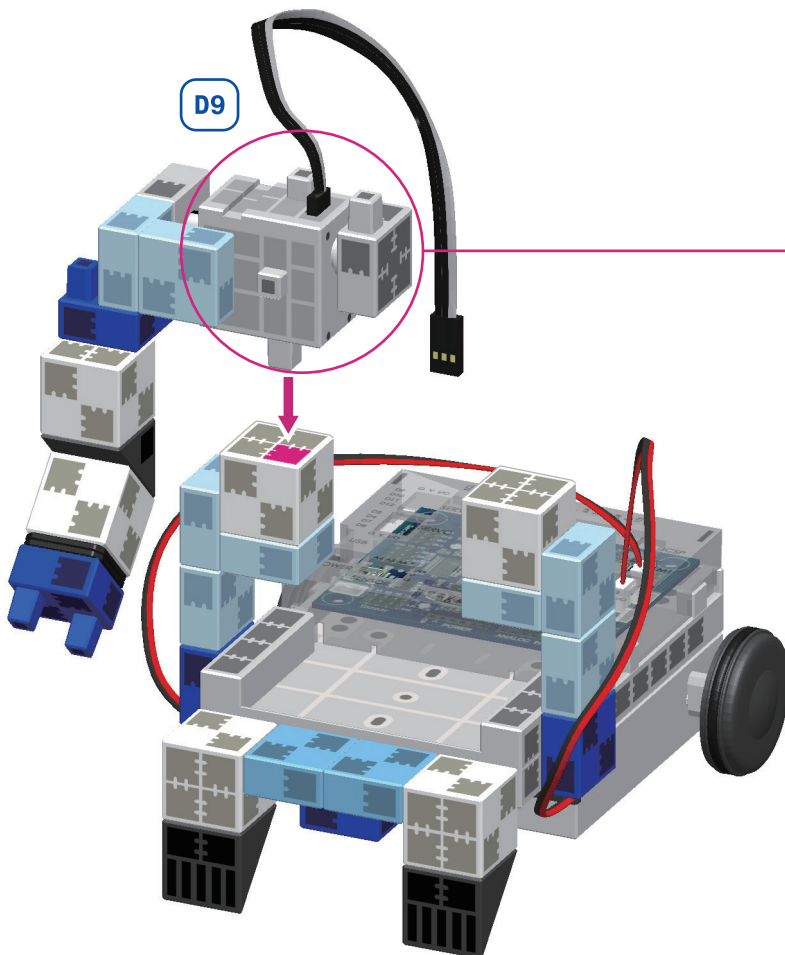

⚠ 注意灰色线的方向!

Sensor Controlled Robot

② Connect the cable from servomotor **D10** to its corresponding place on your Studuino unit.

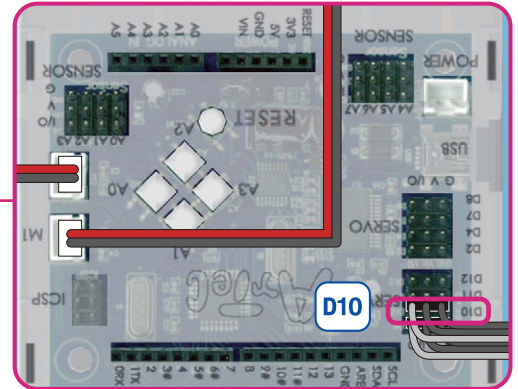
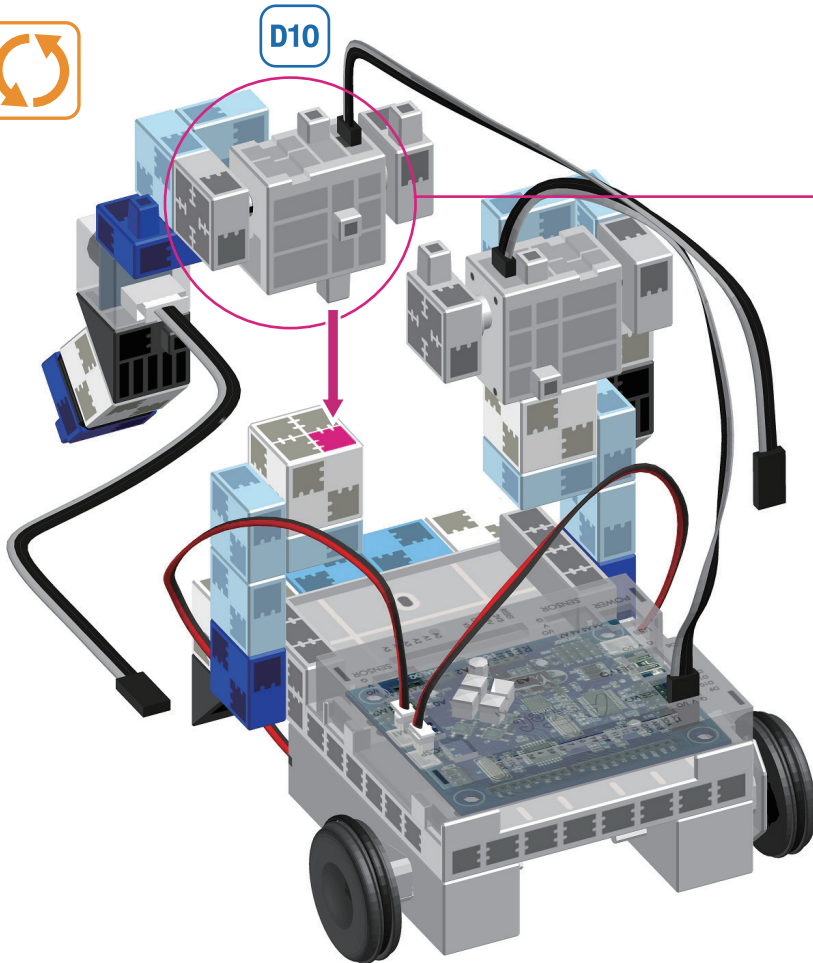

⚠ Make sure the cables are inserted correctly!

③ Connect the cable from the buzzer to **A4**.

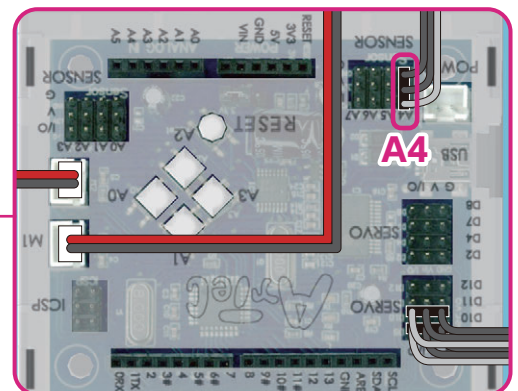
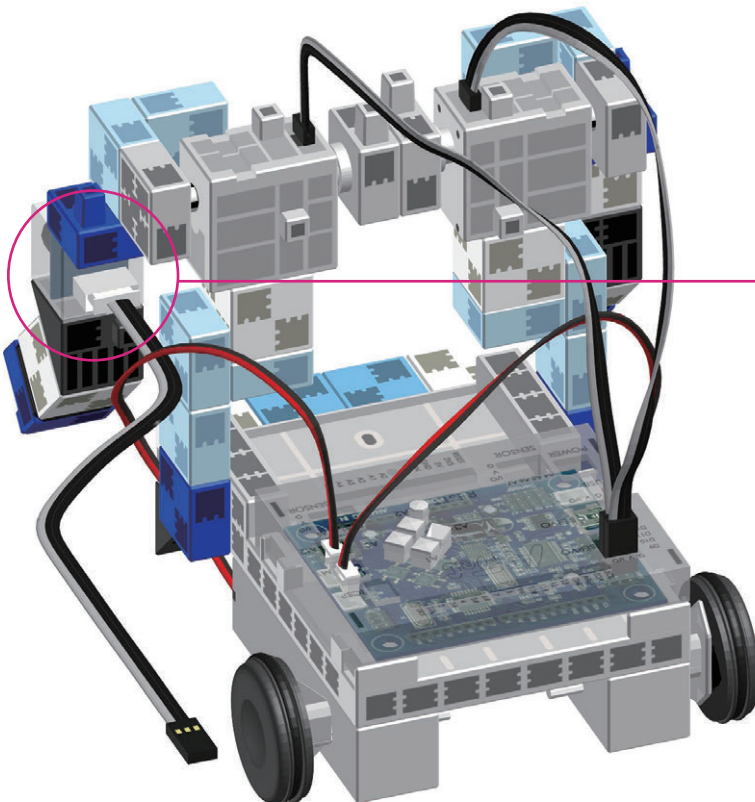

⚠ Make sure the cables are inserted correctly!

Sensor Controlled Robot

- ④ Cables from the LEDs (red, green) on the torso should pass between the arms and lower body.

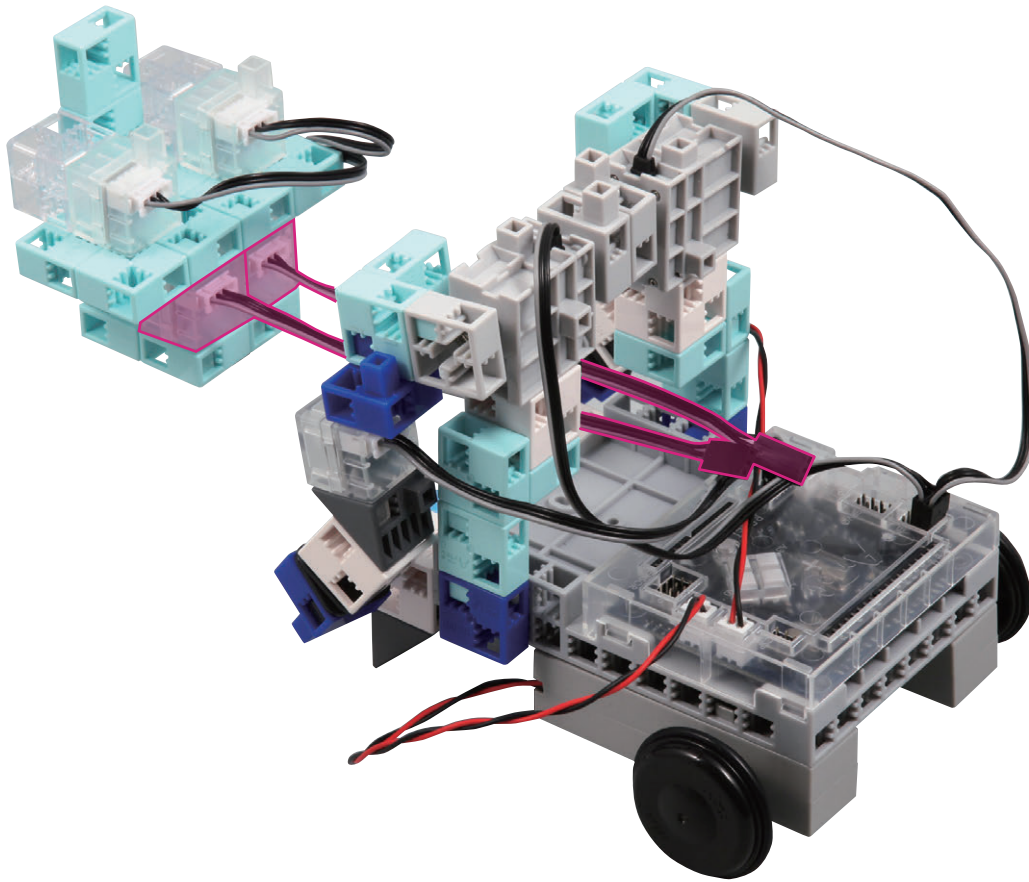

- ⑤ Lift the left arm and attach the torso.

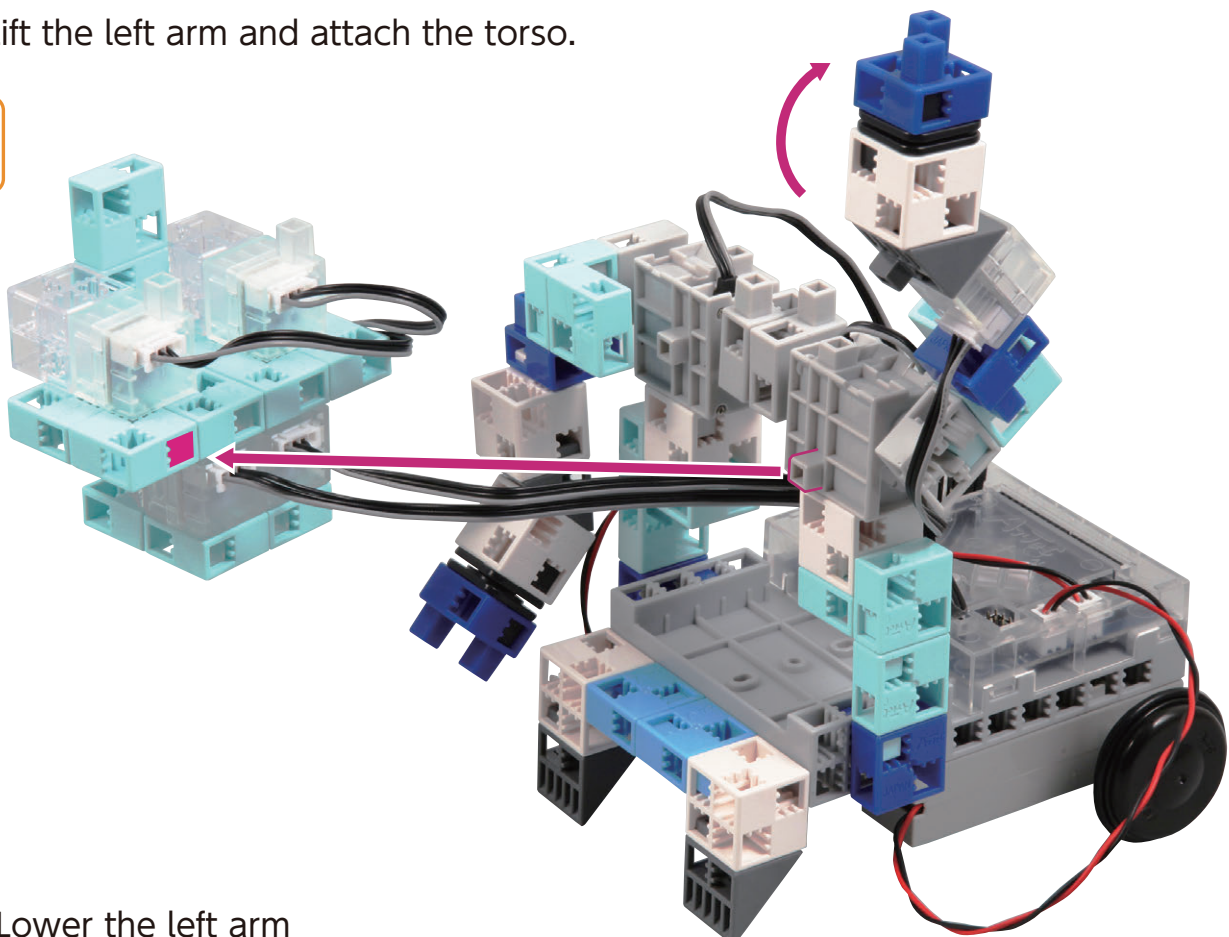

-  Lower the left arm after attaching the torso.

Sensor Controlled Robot

- 8 Arrange the torso LED cables (white, blue) as shown below.
Connect the white LED cable to **A0** and the blue LED cable to **A1**.

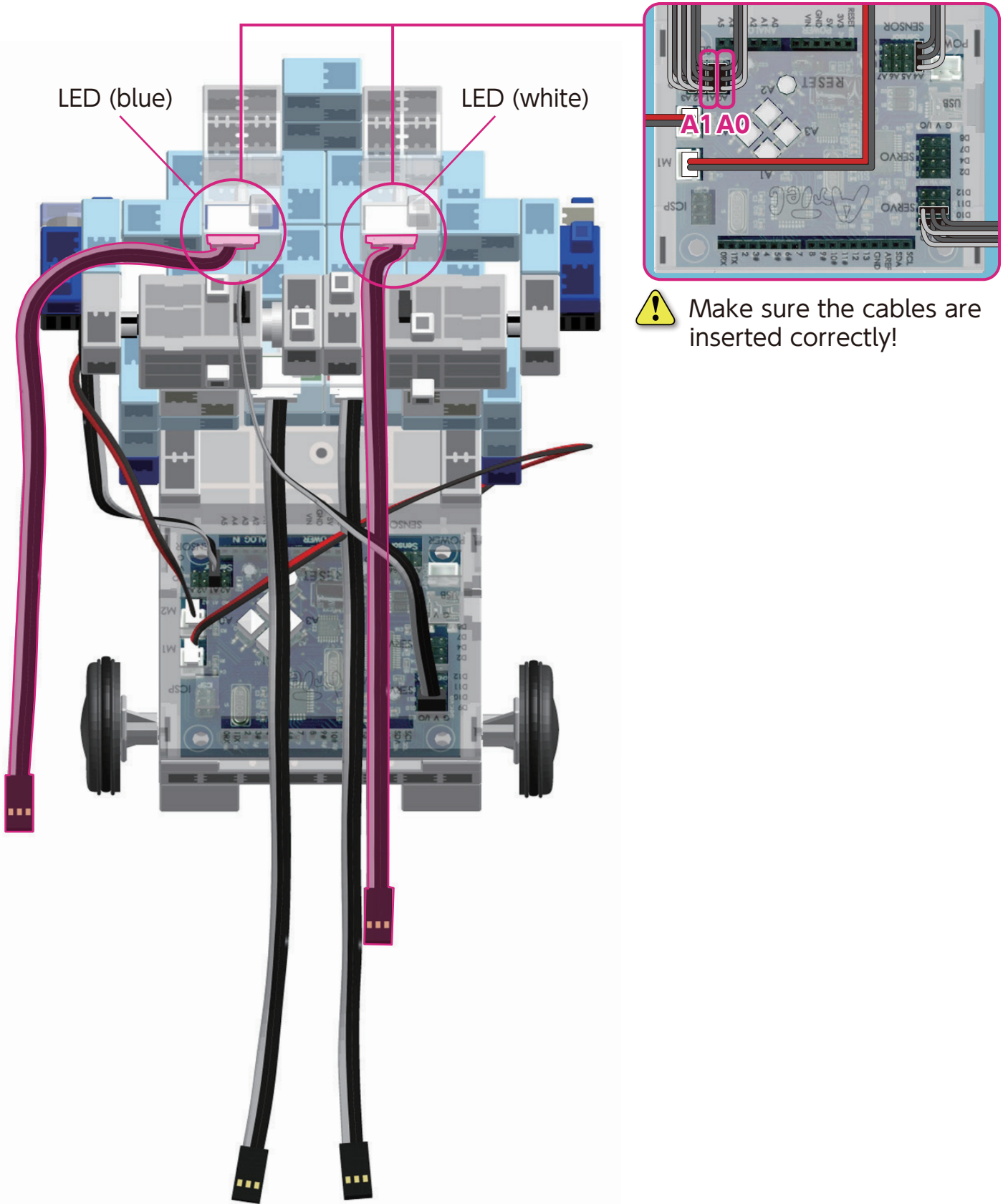



⚠ Make sure the cables are inserted correctly!

Sensor Controlled Robot

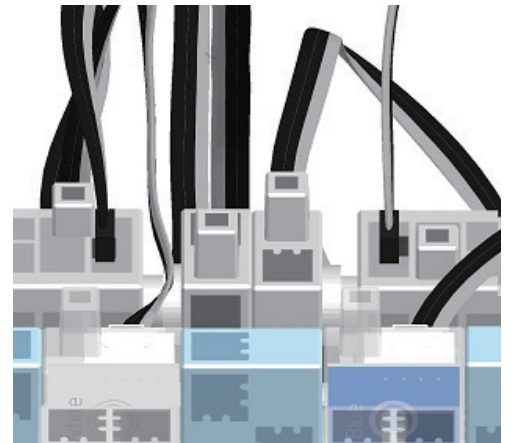
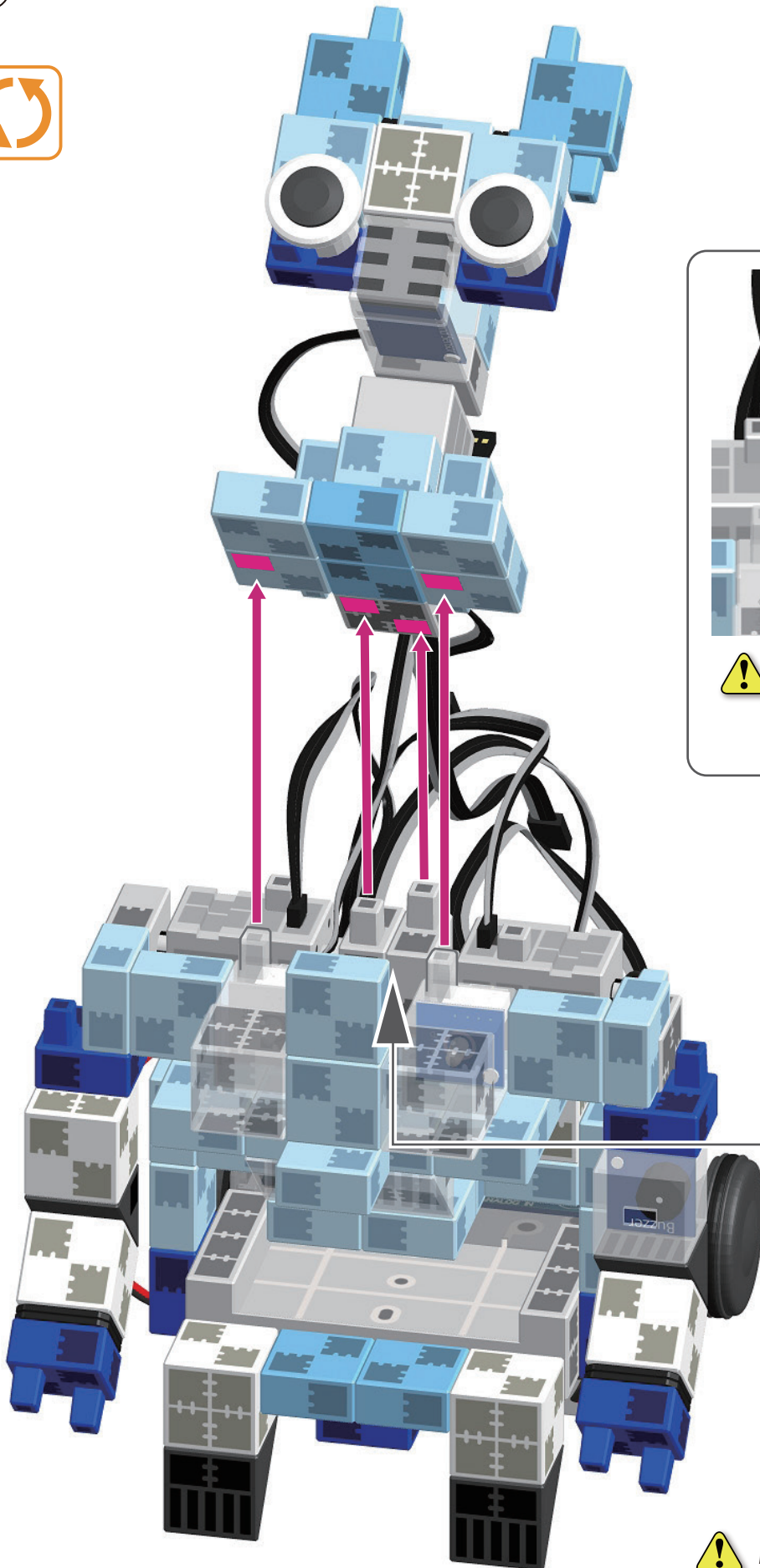
9 Attach the head to the torso.





 Gently turn the studs on the servomotors for both arms upward.

 Make sure not to pinch any cables between blocks.

Sensor Controlled Robot

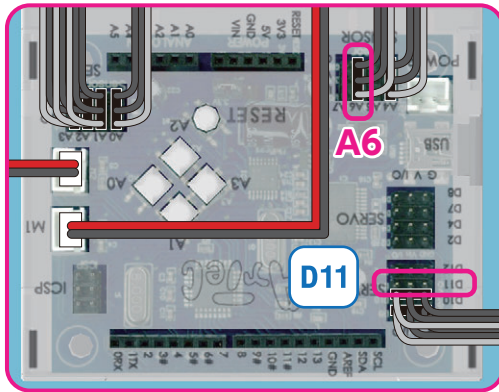
- ⑩ Connect the cable from servomotor **D11** to its corresponding place on your Studuino unit. Connect the sound sensor to **A6**.



 Make sure the cables are inserted correctly!

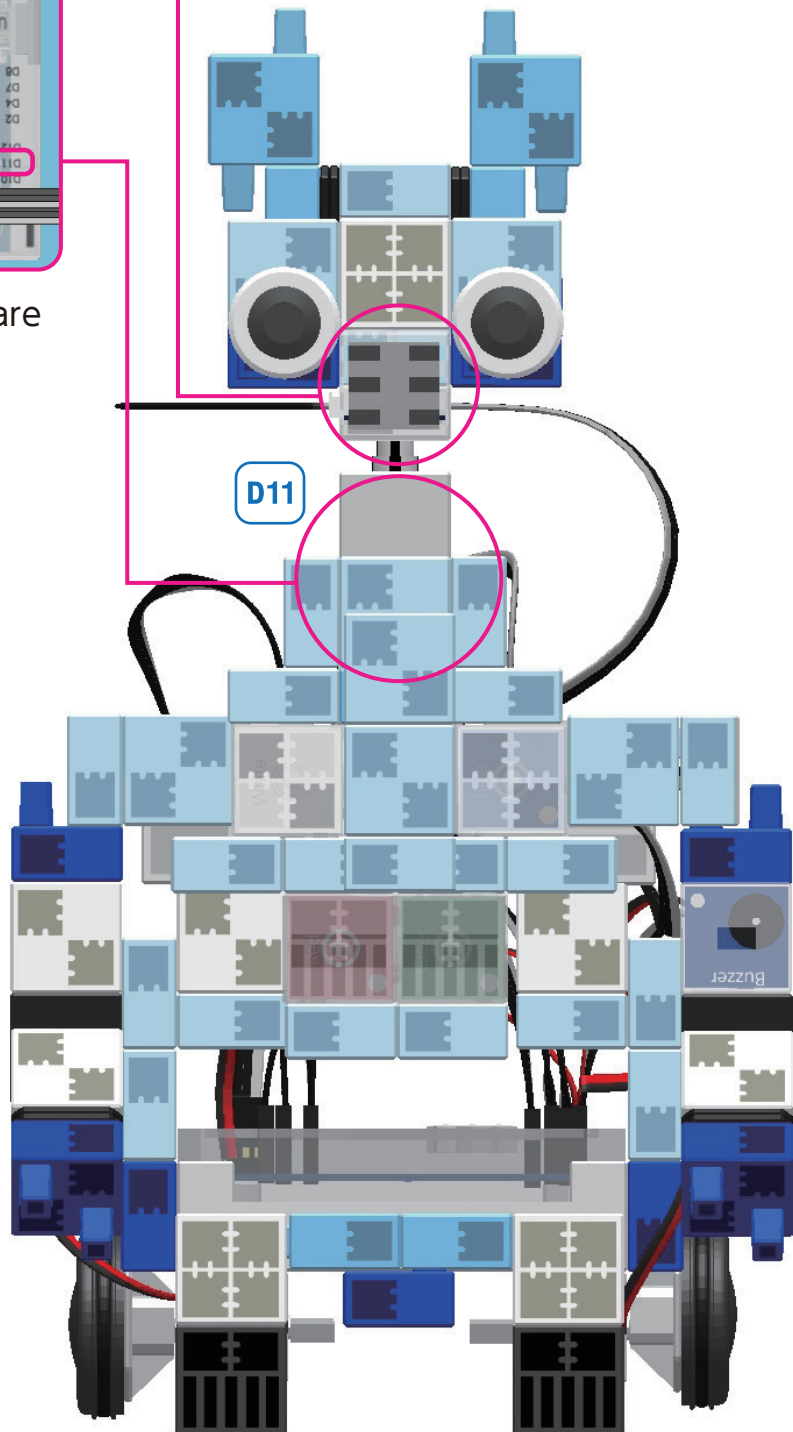

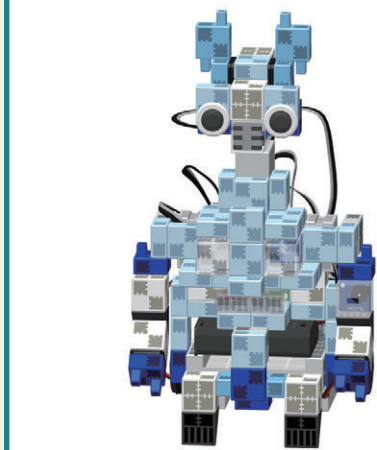
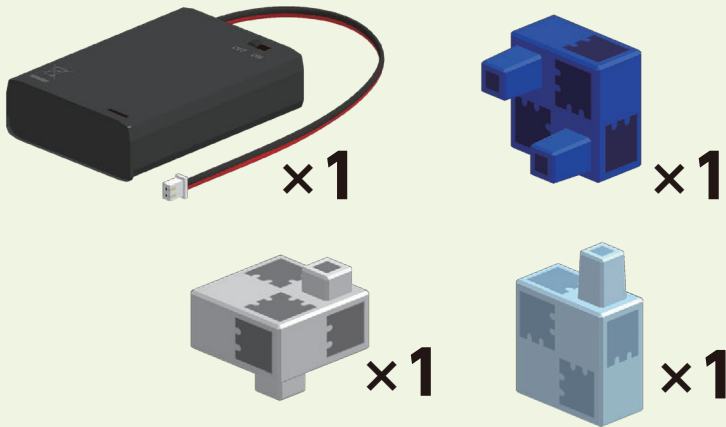

Sensor Controlled Robot

Assembling the Battery Box

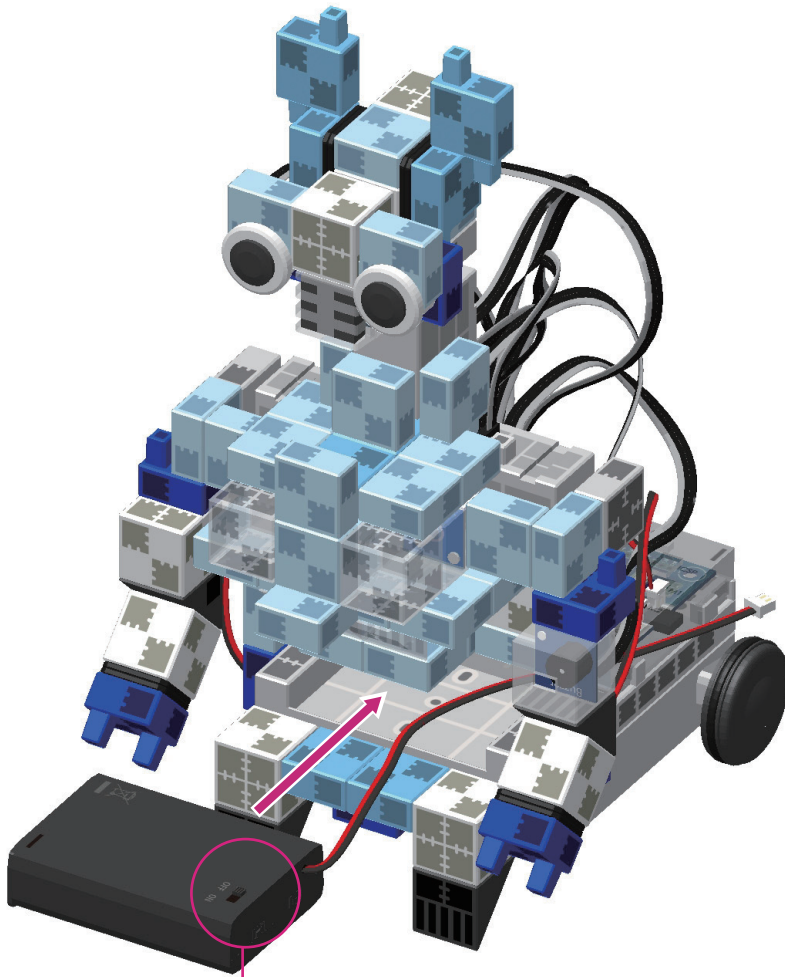

- 1 Insert the battery box between the lower body and the torso.



 You should see the battery box switch here.

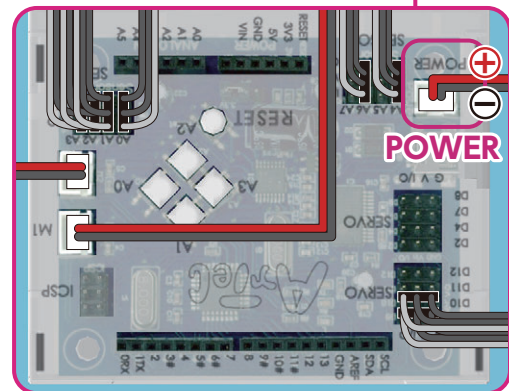
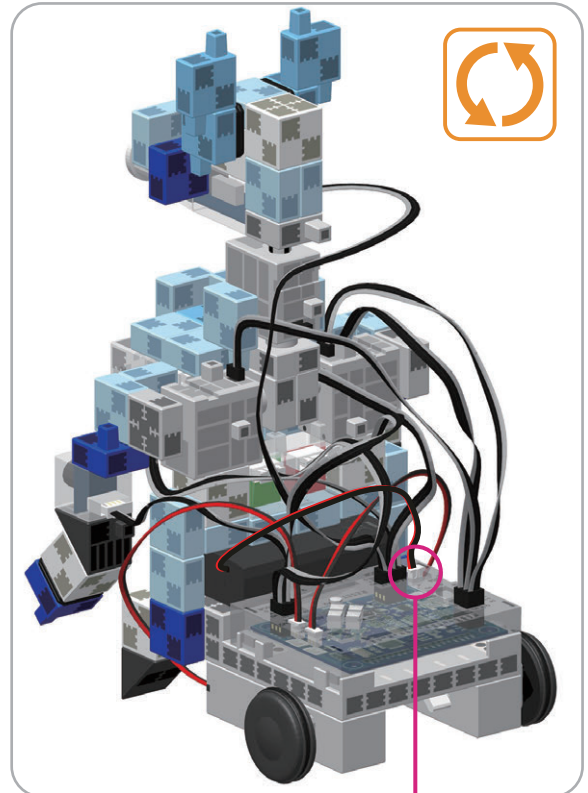

 Make sure the cables are inserted correctly!

Sensor Controlled Robot

②

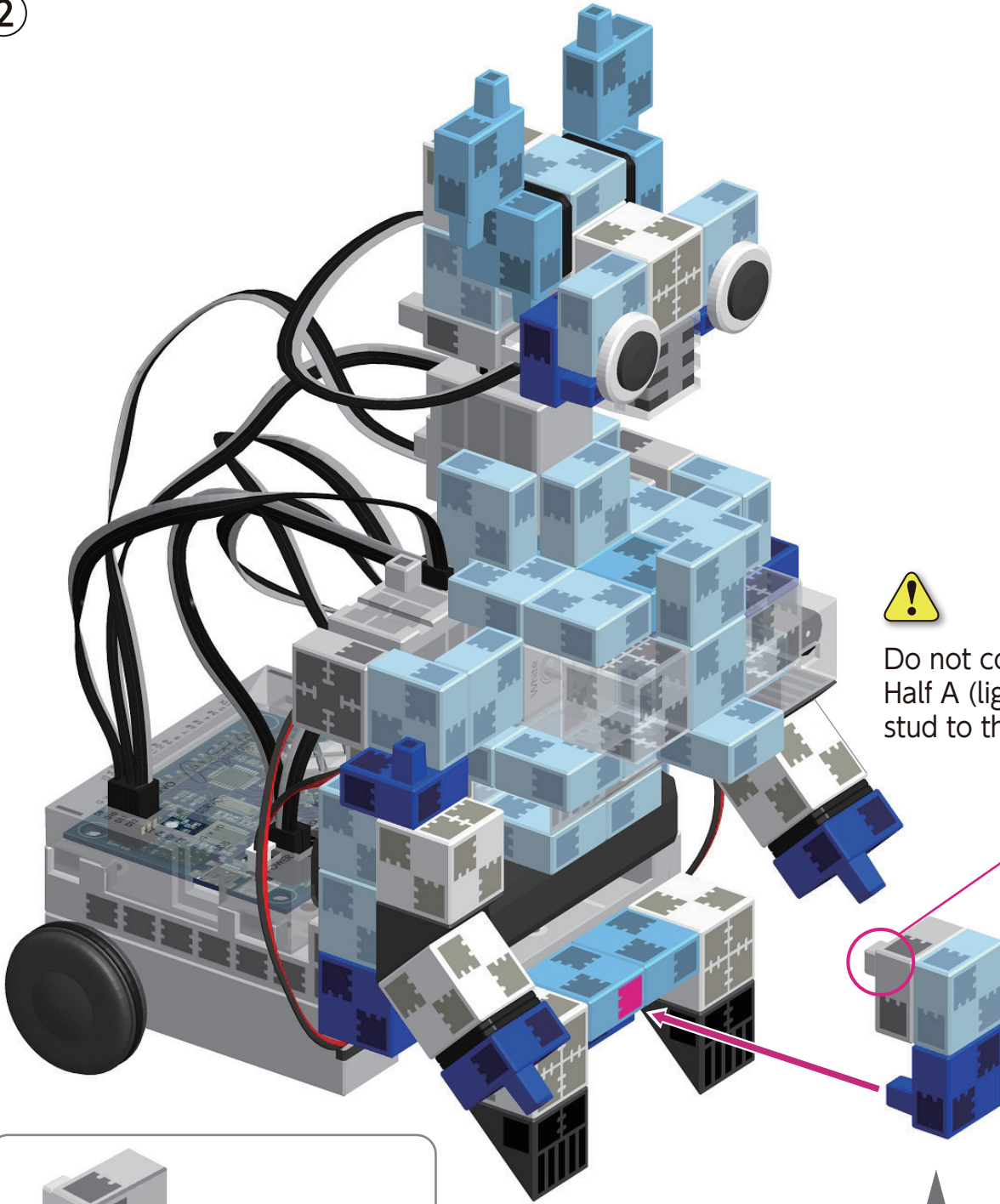

Do not connect the Half A (light gray) stud to the main body.

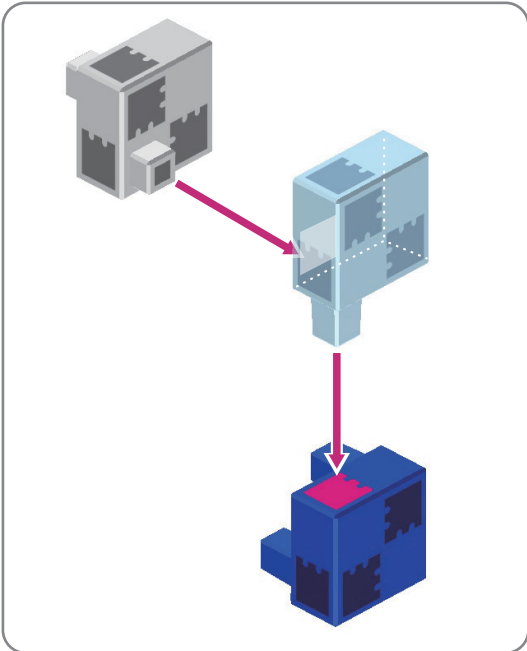

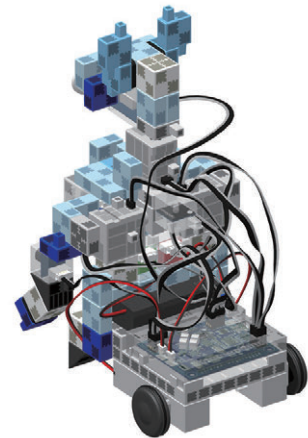
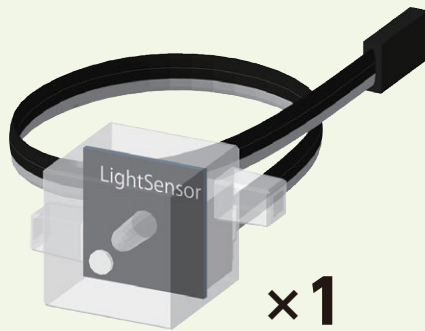

Sensor Controlled Robot

Attaching the Light Sensor

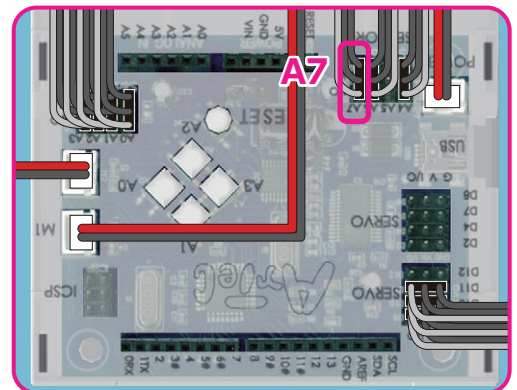
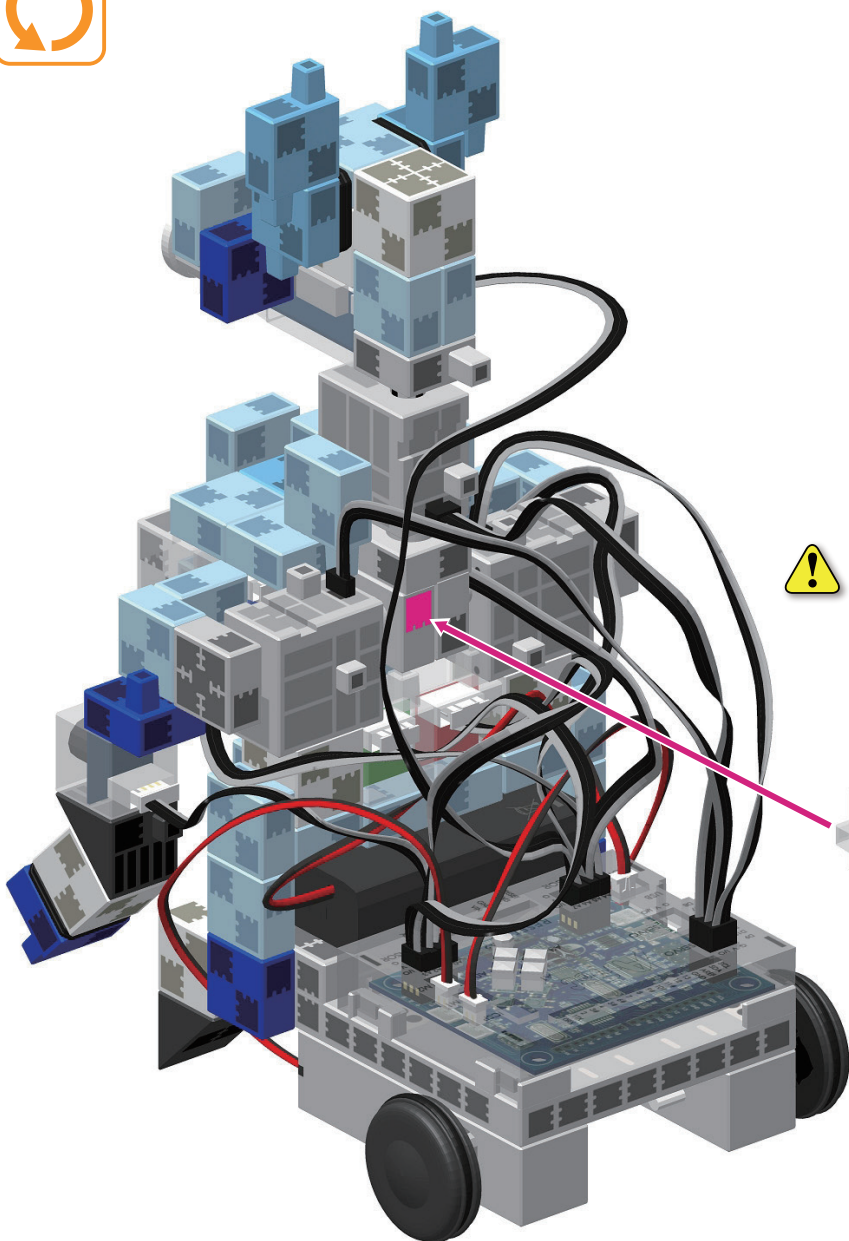

Connect the light sensor to the body and its cable to **A7**.



 Make sure the cables are inserted correctly!

Light Sensor



Sensor Controlled Robot

Replacing the Batteries

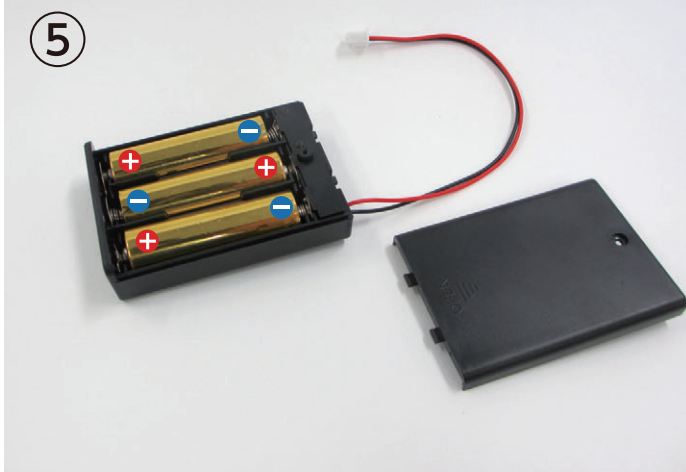
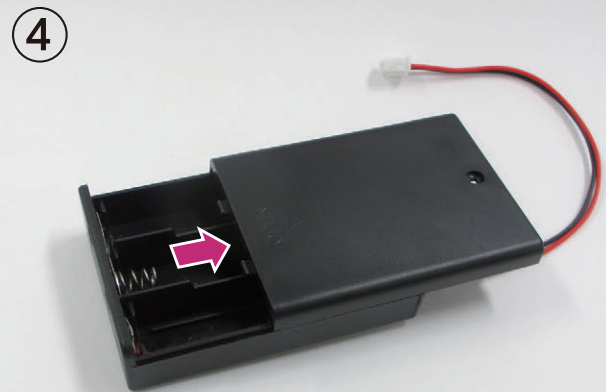
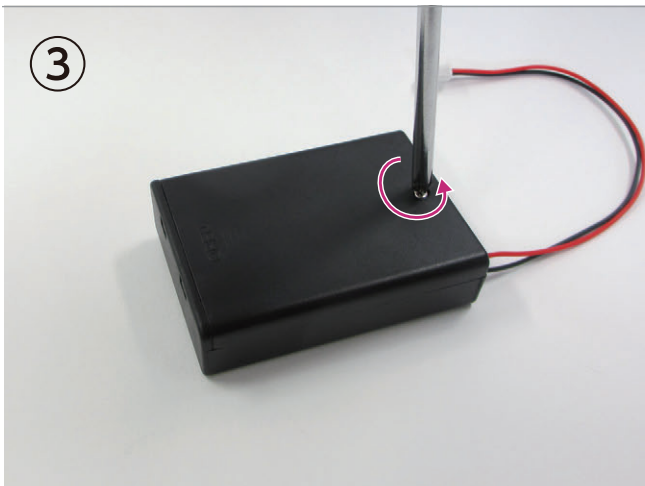
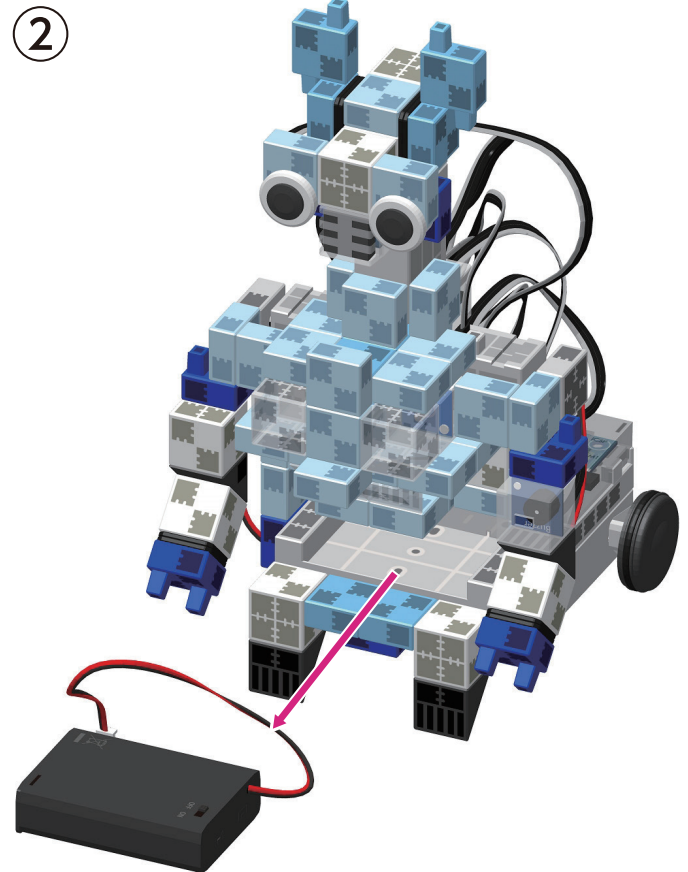
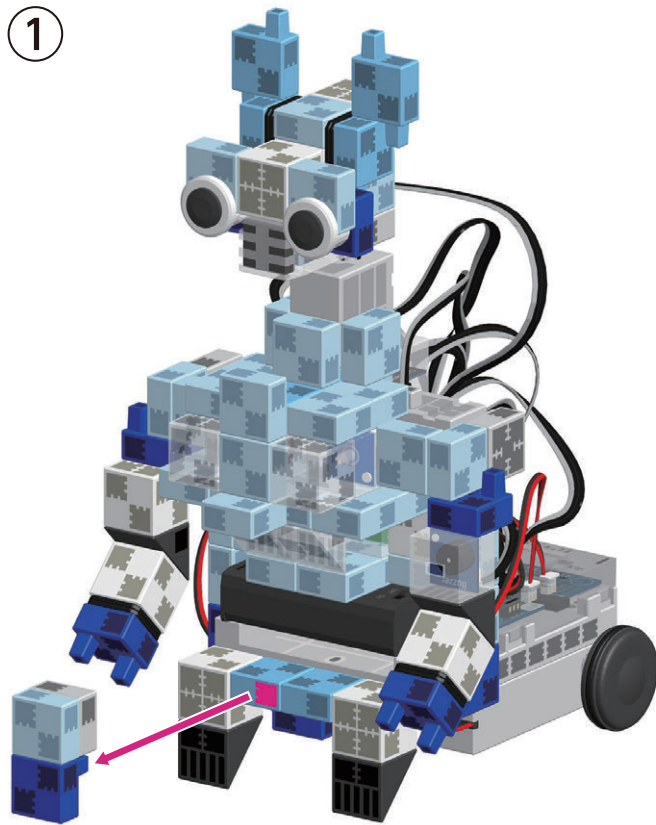

Use a screwdriver (Phillips #1) to open.

 Insert batteries in the correct polarity.

Put the lid of the battery box back in place.

Sensor Controlled Robot

Completed Sensor Controlled Robot



Before operating your robot, check the Assembly Instructions again to confirm your robot has been assembled correctly.

Front

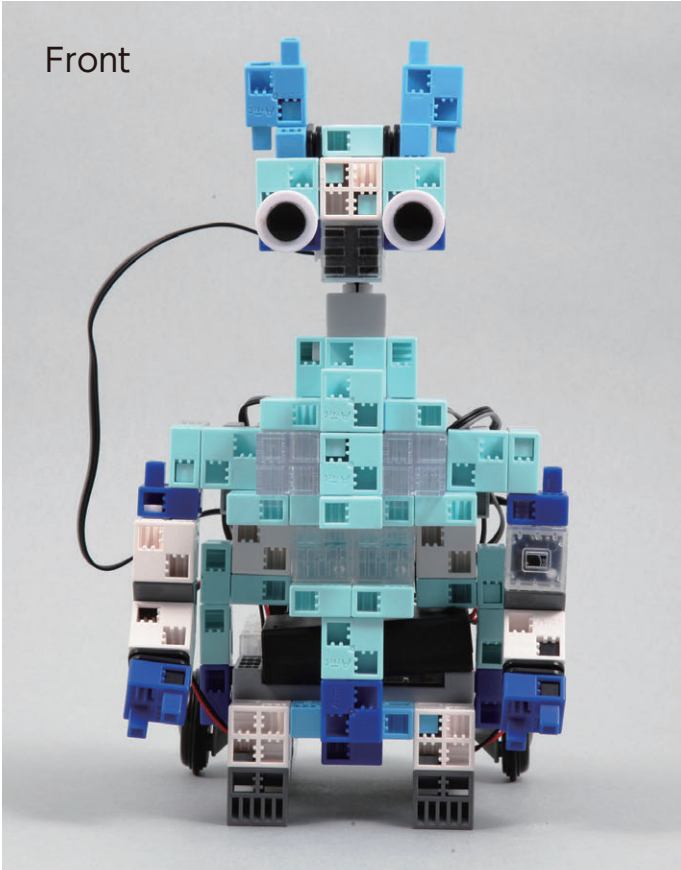

Left

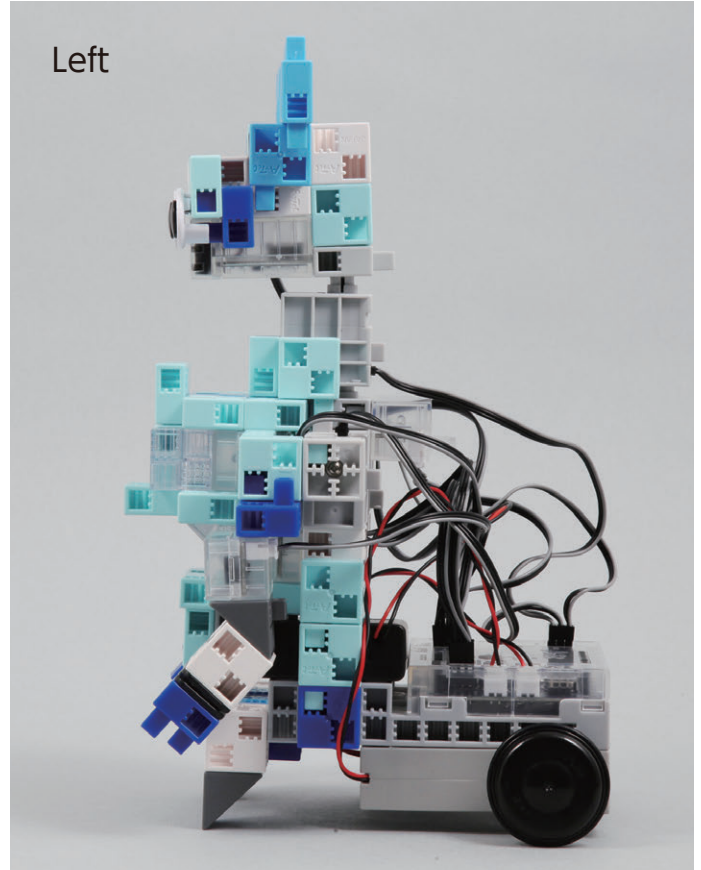

Back

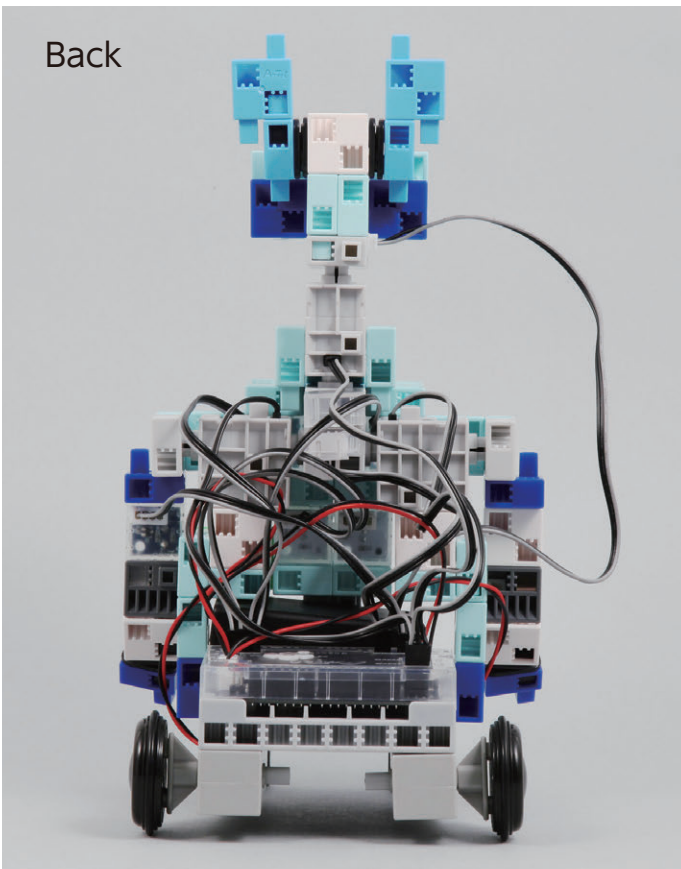

Right

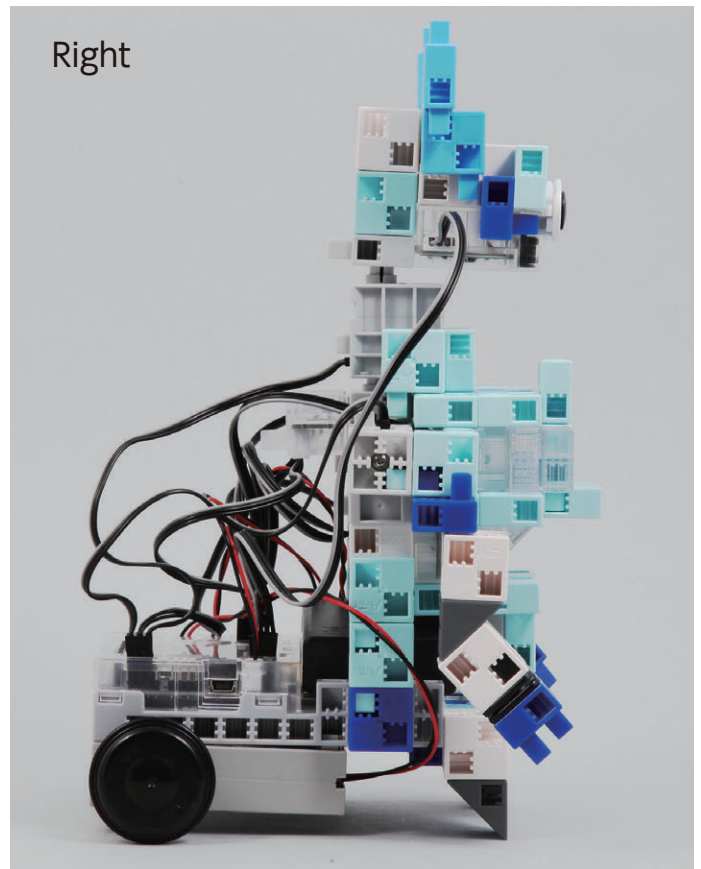

Sensor Controlled Robot

Operating Your Sensor Controlled Robot

Install the software from the URL below to setup the **Studuino Programming Environment**.

★ Proceed to Step 1 when software installation is complete.

<http://www.artec-kk.co.jp/studuino/>

- ① Connect the USB cable to the PC and the Studuino unit.
Refer to **1.3. About Studuino** in **Studuino Programming Environment Manual** for more details.
- ② Download the program file **SensorControlledRobot.ipd_1** from the URL below in the **Robotist** section.

<http://www.artec-kk.co.jp/robotist/>



- ③ Open the downloaded file.

- ④ Transfer the program to the Studuino unit by clicking the Transfer button .



- ⑤ Remove the USB cable from the Studuino unit.

Sensor Controlled Robot



Immediately turn the switch to off if your robot does not begin working as shown in the picture below. Not doing so may damage the servomotor.



If your robot does not move, the servomotor may be in the wrong position or the blocks may be improperly connected. Re-read the Assembly Instructions to make sure that your robot has been assembled correctly.

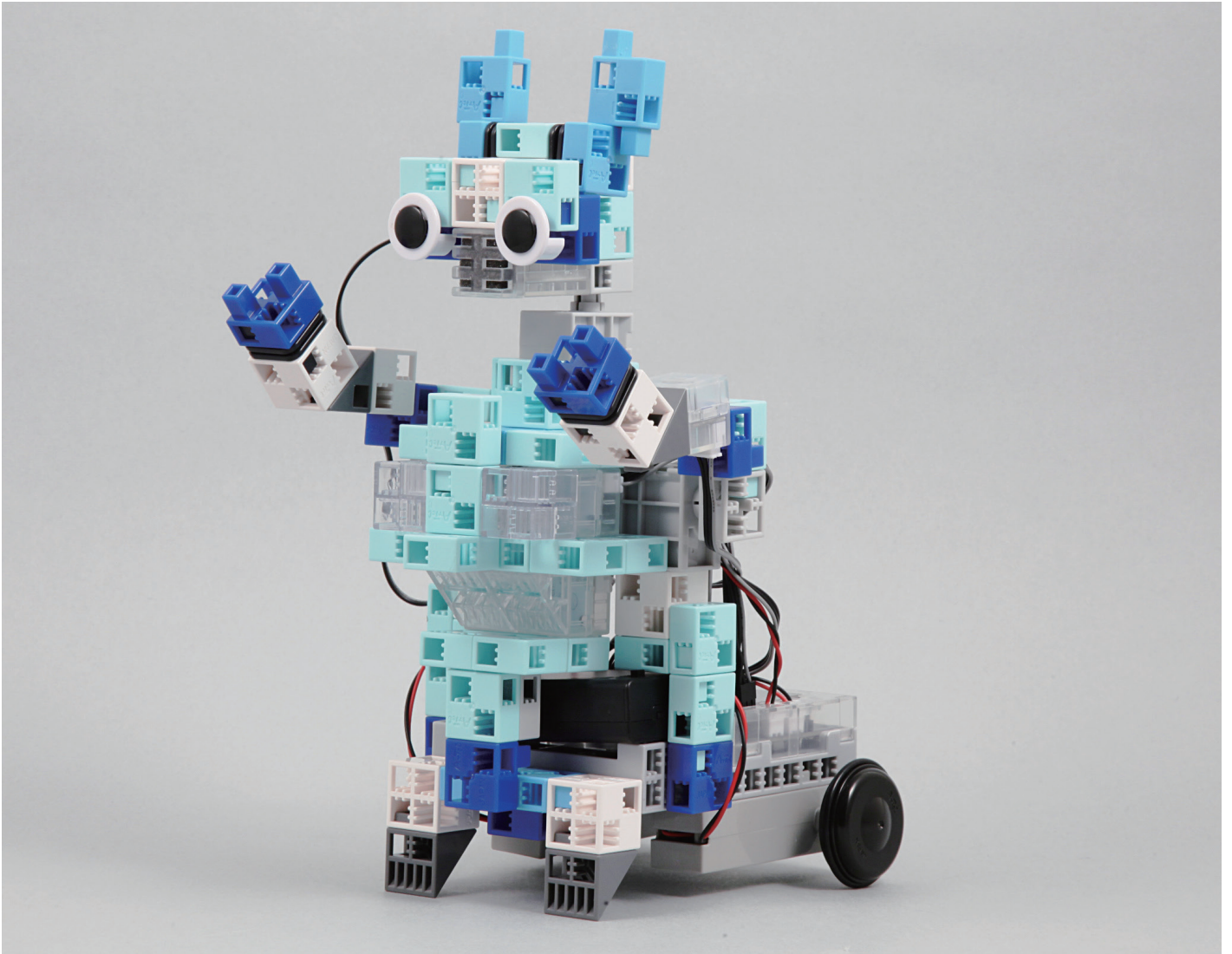

- ⑥ Turn the switch of the battery box on and your robot will start playing music and moving.
- ⑦ Loud sounds will scare your robot and make it run around.
- ⑧ Covering the light sensor on your robot's torso will make it play music.

Sensor Controlled Robot

Sensor Calibration

Some sensors may not function properly after you run the program for the first time. If the sensors are malfunctioning, calibrate the sensor settings.



Click the corresponding sensor and you will see a box to adjust the range settings.

Drag the mouse left or right to adjust the range settings.

Refer to the **Condition Icon** sections in **4.4. The Attribute Field** of the **Studuino Programming Environment Manual** for more details.

Sensor Controlled Robot

Using an Accelerometer with Your Robot

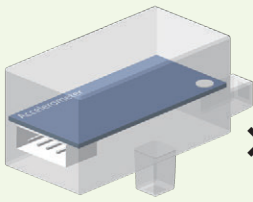

×1

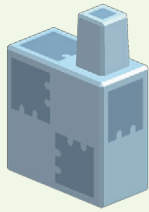

×1

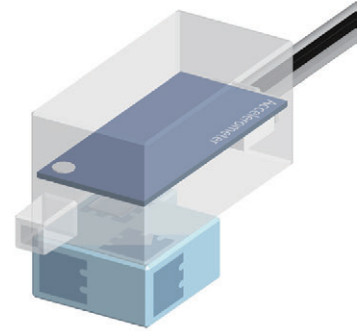

①

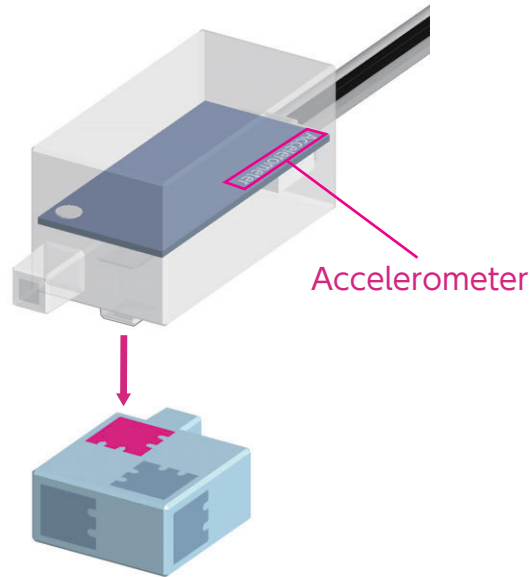

② Unplug the buzzer from **A4** and connect the accelerometer cable to **A4/A5**.

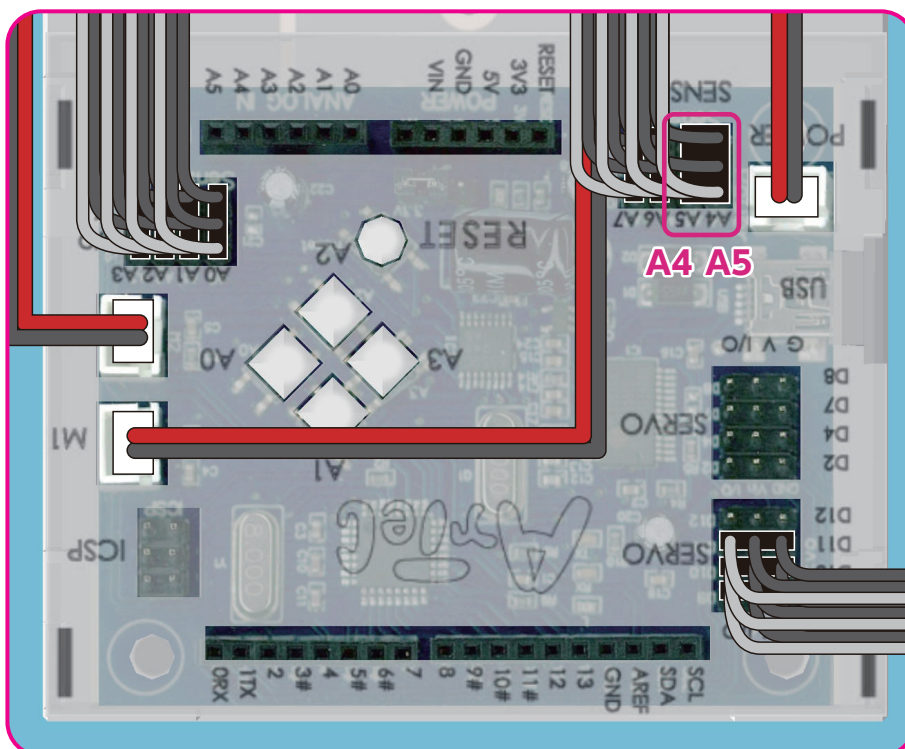

Connect to the accelerometer to both A4 and A5.



Make sure the cables are inserted correctly!

Sensor Controlled Robot

Completed Robot with Accelerometer



Before operating your robot, check the Assembly Instructions again to confirm your robot has been assembled correctly.

Front

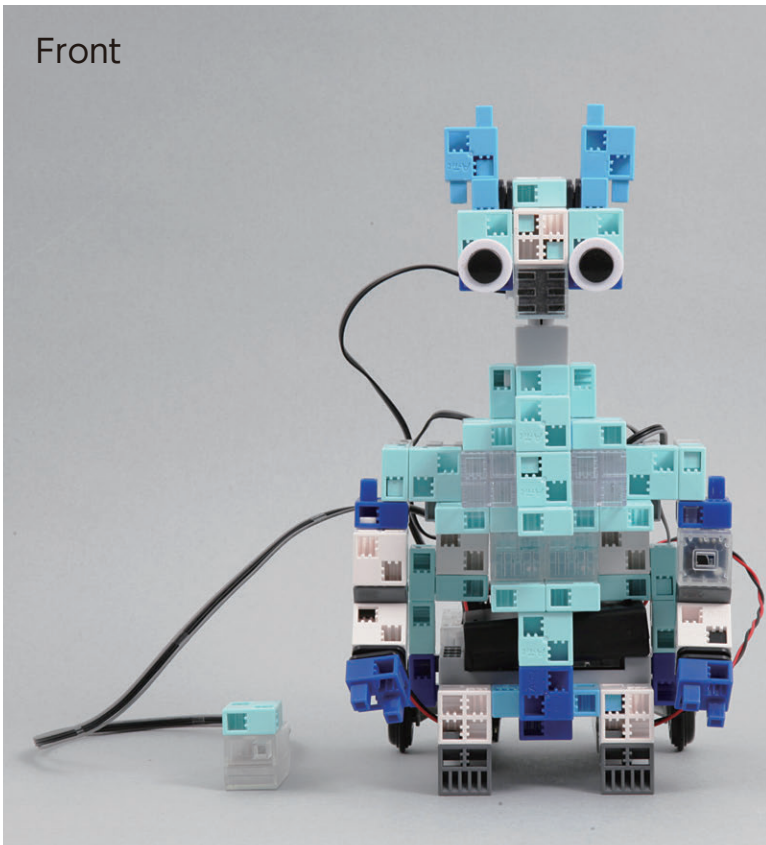

Left

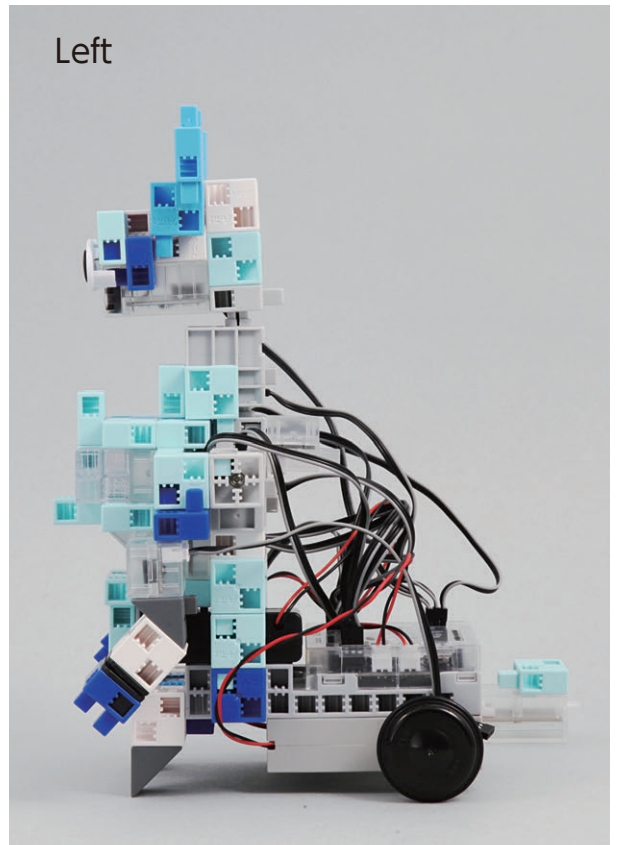

Back

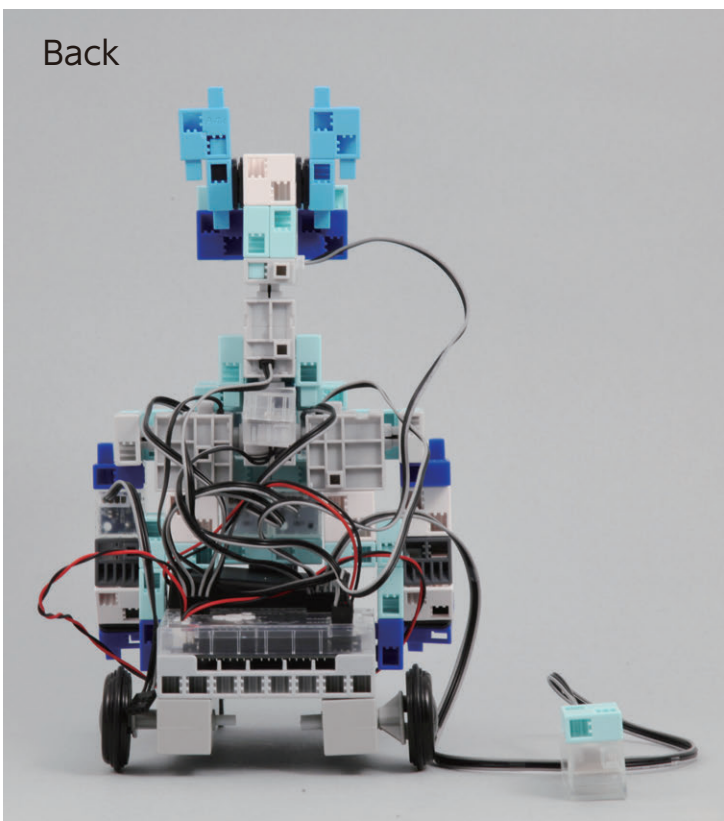

Right

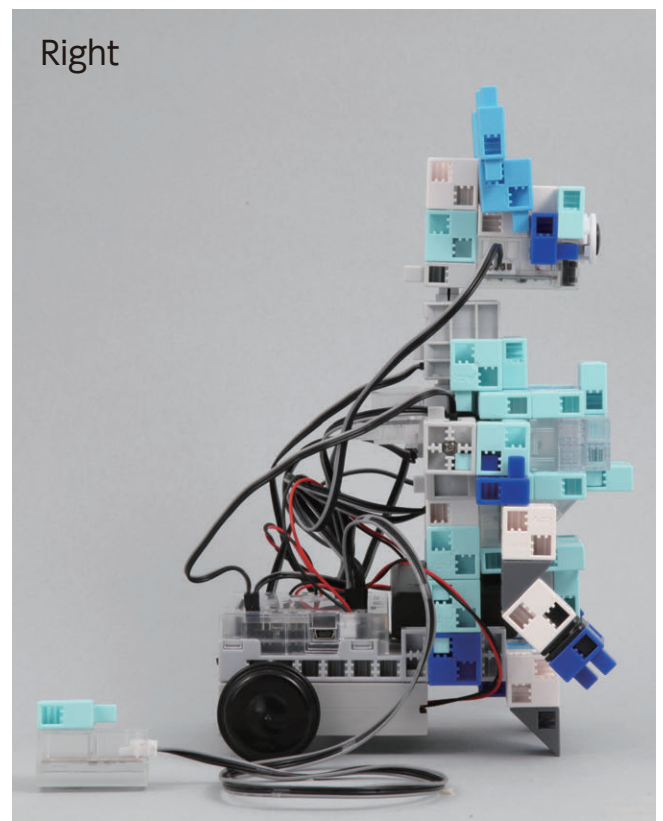

Sensor Controlled Robot

Using the Accelerometer

- ① Transfer **SensorControlledRobot_2.ipd** to your Studuino.
See page 31 of this guide for instructions on how to transfer data.
- ② Turn the switch of the battery box on and tilt the accelerometer to control your robot.

Hold the controller parallel to the ground and tilt it to make your Sensor Controlled Robot move.

<Controls>

Tilt Forward	▶	Go forward
Tilt Backward	▶	Reverse
Tilt Right	▶	Turn right
Tilt Left	▶	Turn left
Push Button	▶	Move arms

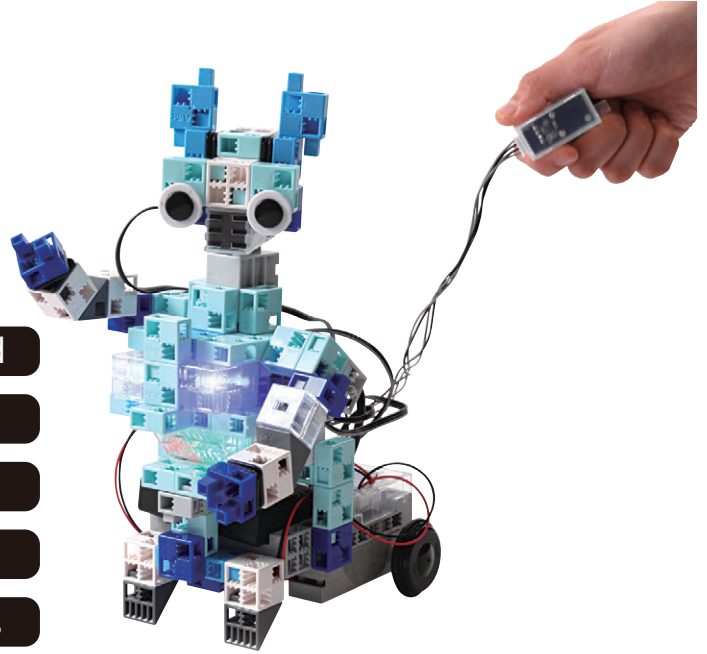

⚠ Immediately turn the switch to off if your robot does not move as shown in the above picture when you tilt your accelerometer to the left. Not doing so may damage the servomotor.

⚠ If your robot does not move, the servomotors may be in the wrong position or the blocks may be improperly connected. Re-read the Assembly Instructions to make sure that your robot has been assembled correctly.

- ③ Covering the light sensor on your robot's torso with your hand will make it change the brightness of its LEDs.

Sensor Controlled Robot

Sensor Calibration

Some sensors may not function properly after you run the program for the first time. If the sensors are malfunctioning, calibrate the sensor settings.



Click the corresponding sensor and you will see a box to adjust the range settings.

Drag the mouse left or right to adjust the range settings.

Refer to the **Condition Icon** sections in **4.4. The Attribute Field** of the **Studuino Programming Environment Manual** for more details.